



Service Manual

SR0818D/SR1018D/SR1218D

**Rough terrain Mobile
Elevating Work Platform**

⚠ WARNING

Before operation and maintenance, the drivers and maintenance personnel are required to read this manual thoroughly. Otherwise, fatal accident may occur. This manual shall be kept properly for future reference by the personnel concerned.

LINGONG HEAVY MACHINERY CO., LTD.

Rough terrain Mobile Elevating Work Platform Service Manual

880*1230 mm Sextodecimo 8 sheets

First edition, June 2022 First print, June 2022

LINGONG HEAVY MACHINERY CO., LTD.

Add.: 12F, Building 3, Lushang Olympic City, No. 9777, Jingshi Road, Lixia District, Jinan
City, Shandong Province, China

Tel: 86-0531-67605017

Technical service: 86-4009666569

Web: www.LGMG.com.cn

Sales of accessories: 86-0531-67605016

Contents

Contents.....	I
Foreword.....	VIII
Safety Notices	IX
1 Safety and Environment	1
1.1 Terms and Definitions.....	3
1.2 Compliance.....	3
1.3 Before maintenance	3
1.4 Workplace requirements	3
1.5 Safety precautions for maintenance and repair	3
1.6 Intended use	4
1.7 Description	4
2 Product Introduction	7
2.1 Machine parameters	9
2.1.1 Parameters of SR0818D off-road scissor lifting platform.....	9
2.1.2 Parameters of SR1018D off-road scissor lifting platform.....	10
2.1.3 Parameters of SR1218D off-road scissor lifting platform.....	12
2.2 Specification for selection of tightening torque of the lifting platform	13
3 Service.....	17
3.1 Platform	19
3.1.1 Removing the working platform	20
3.1.2 Removing the extended platform	20
3.1.3 Subassembling the extended platform	20
3.1.4 The main platform assembly.....	21
3.1.5 Folding the working platform guardrail.....	22
3.2 Platform control unit (PCU)	22
3.2.1 Removing the platform control unit.....	22
3.2.2 Assembling the platform control unit (PCU)	23

3.3	The platform gate	23
3.3.1	Removing the semi-swing gate	23
3.3.2	Installing the semi-swing gate.....	23
3.4	Fork assembly.....	25
3.4.1	Removing forks(SR0818D)	25
3.4.2	Removing forks (SR1018D).....	29
3.4.3	Removing forks(SR1218D)	34
3.4.4	Assembly the Fork	38
3.4.5	Replacing the fork slider at platform.....	46
3.4.6	Replacing the fork slider at chassis	47
3.5	Engine assembly	47
3.5.1	Installing engine mounts.....	47
3.5.2	The pump cover and coupling.....	47
3.5.3	Installing the solenoid valve.....	48
3.5.4	The gear pump	49
3.5.5	Assembling the engine intake system	50
3.5.6	Removing the engine intake system.....	50
3.5.7	Assembling the engine cooling system	51
3.5.8	Removing the engine cooling system.....	51
3.6	Fuel tank and hydraulic oil tank	51
3.6.1	Removing the fuel tank.....	51
3.6.2	Installing the fuel tank	52
3.6.3	Removing the hydraulic tank	52
3.6.4	Installing the hydraulic oil tank	53
3.7	Wheels	53
3.7.1	Removing wheels.....	53
3.7.2	Assembling wheels	54
3.8	Front axle assembly	54

3.8.1	Installing the steering rod and steering cylinder	54
3.8.2	Removing the steering linkage and steering cylinder	55
3.8.3	Installing the steering knuckle and front motor	55
3.8.4	Removing the steering knuckle and front axle motor	56
3.8.5	Assembling the axle swing cylinder	57
3.8.6	Removing the axle swing cylinder	57
3.9	Rear axle assembly	57
3.9.1	Installing the reducer	58
3.9.2	Installing the rear axle motor	58
3.9.3	Removing the rear axle assembly	59
3.10	Outrigger assembly	59
3.10.1	Assembling the outrigger cylinder	59
3.10.2	Removing the outrigger cylinder	60
3.10.3	Installing the level meter	60
3.11	Other components	61
3.11.1	Installing the hydraulic oil radiator	61
3.11.2	Installing the DC power switch	62
3.11.3	Installing the high pressure filter	62
3.11.4	Installing the battery	62
3.12	Valve group	64
3.12.1	Installing the spool	64
3.12.2	Lift control valve	64
3.12.3	Walking control valve	65
3.12.4	Lower lift cylinder control valve	66
3.12.5	Lower cylinder valve block	67
3.12.6	Pressure sensor on lifting control valve	68
3.13	Schematic diagram of location of main appliances	69
4	Commissioning	71

4.1	Safety instructions	73
4.2	Test of basic functions	74
4.2.1	Start/stop test.....	74
4.2.2	Lifting/lowering function test	74
4.2.3	Steering test	74
4.2.4	Horn test.....	75
4.2.5	Drive and brake function test.....	75
4.3	No-load test.....	75
4.3.1	Outrigger leveling	75
4.3.2	Fork and platform	75
4.4	Relief pressure test.....	76
4.4.1	System.....	76
4.4.2	Lifting	76
4.4.3	Steering	76
4.5	Calibration test	76
4.5.1	Inclination calibration	77
4.5.2	Outrigger leveling	77
4.5.3	Adjustment of level meter	77
4.6	Inclination test.....	77
4.6.1	Fore-and-aft 3°	77
4.6.2	Left-and-right 2°	78
4.7	Load calibration.....	78
4.7.1	Idle load.....	79
4.7.2	Rated load	79
4.8	Overload function.....	80
4.8.1	Start.....	80
4.8.2	Parameter setting	80
4.8.3	Test with 1.2 times rated load.....	80

4.8.4	Overload recovery	81
4.8.5	Test with 1.25 times rated load.....	81
4.9	No-load lifting time	81
4.9.1	No-load lifting time test.....	81
4.9.2	Adjustment of lifting speed.....	82
4.9.3	Adjustment of lowering speed.....	82
4.10	Emergency lowering test	82
4.11	Outrigger limit test(Idle load)	83
4.12	Floating test.....	83
4.13	Function test.....	84
4.13.1	Anti-pinch function	84
4.13.2	Beacon function.....	84
4.13.3	Operation alarm function	84
4.13.4	Outrigger function	85
4.13.5	Overload function.....	85
4.13.6	Fuel level inspection function	85
4.13.7	Lifting height for overload alarm.....	85
4.14	Basic operation.....	86
5	Maintenance	89
5.1	Checking the safety manual.....	91
5.2	Checking the labels and signs	91
5.3	Checking for damaged, loose or missing parts.....	91
5.4	Checking the GCU	92
5.5	Checking the PCU	92
5.6	Checking the wires	92
5.7	Checking the battery	93
5.8	Checking the tires and wheel hubs	94
5.9	Checking the hydraulic tank vent cap	94

5.10	Checking for leakage of hydraulic oil.....	94
5.11	Checking the hydraulic filter	95
5.12	Replacing the air filter of the hydraulic tank	96
5.13	Checking the hydraulic oil level.....	96
5.14	Checking or changing the hydraulic oil	96
5.15	Checking the oil level of the reducer	97
5.16	Changing the reducer gear oil.....	98
5.17	Checking the cooling system.....	98
5.18	Maintenance of Kubota engine.....	98
5.18.1	Checking the engine oil level	98
5.18.2	Changing engine oil and replacing oil filter	99
5.18.3	Checking fuel leaks	100
5.18.4	Cleaning or replacing the fuel filter.....	100
5.18.5	Bleeding the fuel system.....	101
5.18.6	Cleaning or replacing the air cleaner	101
5.18.7	Checking the coolant level	102
5.18.8	Adding or changing engine coolant.....	102
5.18.9	Checking the engine belt	103
5.19	Engine DTCs.....	104
5.20	Checking or replacing the scissor arm slider	107
5.21	Scheduled maintenance	107
5.22	Routine Inspection and Maintenance Intervals.....	108
6	Appendix	113
6.1	Machine fault codes	115
6.2	Electrical schematic diagram	127
6.2.1	SR18D Electrical schematic diagram	127
6.3	Hydraulic schematic diagram.....	128
6.3.1	SR0818D、SR1018D Hydraulic schematic diagram.....	128

6.3.2	SR1218D Hydraulic schematic diagram	129
6.4	Diagram of common hydraulic part symbols.....	130
6.5	Diagram of common electrical part symbols.....	137

Foreword

You are welcome to purchase and use the products produced by Lingong Heavy Machinery Co., Ltd. This manual introduces the technical parameter and maintenance adjustment data of Rough terrain elevating work platform, and explains the troubleshooting and maintenance process for qualified professional maintenance personnel. The information contained in this manual are correct at the time of publication, but due to the continuous improvement of the structure and performance of our products, the design as well as operation and maintenance instructions of the product may be subject to change without notice. For the latest information about the machine and questions about this manual, please contact our company. At the same time, we encourage readers to feedback errors to Lingong Group Jinan Heavy Machinery Co., Ltd. and put forward suggestions for improvement. All suggestions will be carefully considered in the future publication and printing of this manual.

The copyright of this manual belongs to Lingong Heavy Machinery Co., Ltd., and it is not allowed to be copied or reprinted without the written permission of our company.

WARNING

- Only specially trained and qualified personnel can operate, repair and maintain the machine.
- Incorrect operation, maintenance and repair are dangerous and can lead to personal injury or death.
- Before operating or maintaining the machine, the operator should read this manual carefully. Do not operate, maintain or repair this platform without reading and understanding this manual.
- Please load the machine in strict accordance with the rating, otherwise all the consequences arising from overloading or unauthorized modification will be borne by the user.
- The operating procedures and precautions provided in this manual are only applicable to the specified purposes of this machine. If it is used for operations other than those specified but not prohibited, make sure that this operation does not cause harm to you or others.

Safety Notices

The operator should understand and follow the current national and local safety regulations. If there are no national or local regulations, the safety instructions in this manual shall be applicable.

Most accidents are caused by failure to comply with the regulations on the operation and maintenance of the machine. In order to avoid accidents, please read, understand and observe all warning requirements and precautions in this manual and on the machine before operation and maintenance. Failure to comply with the instructions and safety rules in this manual and the corresponding manual on the machine will result in death or serious injury.

Since it is impossible to foresee all possible dangers, the safety instructions in this manual and on the machine cannot include all safety precautions. If steps and operations not recommended in this manual are used, you must ensure that you and other people are safe and the machine will not be damaged. If you are not sure about the safety of some operations, please contact our company or dealer.

Some operations to the machine require not only basic mechanical, hydraulic and electrical skills, but also professional skills, tools, lifting equipment and suitable workshop. In these cases, we strongly recommend that the maintenance and repair should be carried out at a service center authorized by Lingong Heavy Machinery Co., Ltd.

The maintenance precautions given in this manual are only applicable when the machine is used for the specified purpose. If the machine is used in the scope out of this manual, our company will not assume any safety responsibility, and the safety responsibility in such operations shall be borne by the user and the operator. Under no circumstances shall the operations prohibited in this manual be performed.

Most of the maintenance process can only be performed by trained professional service personnel in properly equipped workshops.

 **DANGER** - Indicating any existing dangers that, if not avoided, will cause serious injury or even death, and also serious machine damage.

 **WARNING** - Indicating any potential dangers that, if not avoided, may cause death or serious injury, and also serious machine damage.

 **CAUTION** - Indicating situations that, if not avoided, may cause minor or moderate injury, and also machine damage or shortened machine service life.

1 Safety and Environment

1.1 Terms and Definitions

Administrator: the entity or individual that directly controls the use and application of the lifting platform, which usually refers to the owner, the renter or the authorized personnel of owner who obtains the control right of the lifting platform;

Operator: personnel who has been professionally trained and mastered qualified knowledge and practical experience to operate the lifting platform.

Qualified personnel: those with recognized academic qualifications, certificates, professional status, or relevant professional knowledge, trained and experienced, who can effectively prove their ability to solve the difficulties encountered in related matters, work or projects.

Safety notice: relevant safety information issued by Lingong Heavy Machinery Co., Ltd.

1.2 Compliance

1. The maintenance is required to be carried out by personnel who have received and qualified in the maintenance training of this machine.
2. Immediately mark the machine if it is damaged or faulty, and withdraw it out of service.
3. Repair any damage or fault before operating the machine.

1.3 Before maintenance

1. Read and follow the safety rules and maintenance instructions in the corresponding operation manuals on the machine.
2. Ensure that all necessary tools and parts are in place.
3. Do not use parts not sold by Lingong Heavy Machinery Co., Ltd.
4. Please read each step thoroughly and follow the instructions, and do not try to perform repair by shortcut, as this is dangerous.

1.4 Workplace requirements

Unless specially specified, the machine shall be able to operate safely under the following conditions:

1. Altitude $\leq 1000\text{m}$;
2. Ambient humidity $\leq 90\%$ (at $+25^{\circ}\text{C}$).
3. The machine shall be able to operate normally under the following safe conditions:
 - Ambient temperature of $-20^{\circ}\text{C} \sim +40^{\circ}\text{C}$;
 - Wind speed: $\leq 12.5\text{m/s}$.
4. During normal operation or maintenance, please set up protective devices as the movement of mechanism and parts may cause danger to human body.
5. Take measures to prevent the danger caused by parts falling from the platform.

1.5 Safety precautions for maintenance and repair

1. Before adjusting and repairing the machine, the following preventive measures shall be taken
 - Park the machine on a solid and level ground
 - Block the wheels
 - Cut off the power supply to disable the machine;
 - Set all controls in “OFF” position to prevent the operating system from being started by

accident;

- If possible, lower the platform to the lowest position, otherwise, ensure that it will not fall;
- Before loosening or removing hydraulic components, release the hydraulic oil pressure in the hydraulic pipeline;
- Place safety supports as required.

2. Maintenance personnel training

Maintenance personnel must be trained by qualified personnel to inspect and maintain the machine in accordance with the requirements of this manual.

3. Parts replacement

The replacement components and parts must be the original parts of our company, otherwise the product will not be maintained or repaired.

4. Service announcement

Users shall maintain and repair the machine in strict accordance with the service announcement issued by Lingong Heavy Machinery Co., Ltd.

1.6 Intended use

This machine is only intended for lifting people and their tools and materials to a high-altitude workplace.

1.7 Description

Most maintenance processes can only be performed by professionally trained maintenance personnel in a properly equipped workshop. After troubleshooting, select the appropriate maintenance steps.

Perform the disassembly steps until the repair can be completed. Then perform the disassembly steps in the reverse order.

It is strongly recommended to carry out maintenance and repair at the service center authorized by Lingong Group Jinan Heavy Machinery Co., Ltd.

Symbol representation

Symbols, color codes and symbolic words used by LGMG products have the following meanings:

Safety warning sign - used for warning of potential personal injury. Observe all safety tips after this sign to avoid possible personal injury or death.



Red - Indicating a hazardous situation. If it is not avoided, it will lead to death or serious injury of personnel.



Orange - Indicating a hazardous situation. If it is not avoided, it may cause death or serious injury.



Yellow - Indicating a dangerous situation. If not avoided, it may cause minor or moderate personal injury.

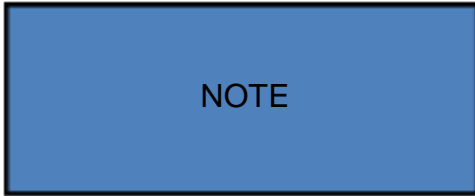

Blue - Indicating a dangerous situation. If not avoided, it may result in property damage.

2 Product Introduction

2.1 Machine parameters

2.1.1 Parameters of SR0818D off-road scissor lifting platform

1. Parameters of machine

Item	Parameter	Item	Parameter
Rated load (kg)	680	Fork lifting time (s)	35±4
Extended platform rated load(kg)	140	Fork lowering time (s)	30±4
Total weight(kg)	3700	Theoretical max. gradeability (no-load, stowed)	40%
Max. allowed workers (outdoor/indoor)	4/4	Max. outrigger leveling angle (from front to rear)	-
Max. working height (m)	9.7	Maximum outrigger leveling angle (from left to right)	-
Max. platform height (m)	7.7	Max. allowed inclination	X-direction: left/right 2°
Max. travel height (m)	7.7		Y-direction: front/rear 3°
Min. turning radius (m)	4.75	Max. inner wheel turning angle	45°
Max. travel speed (stowed) (km/h)	5.5±0.5	Max. allowed wind speed (m/s)	12.5
Max. travel speed (extended) (km/h)	0.5±0.2	Drive mode	Four-wheel drive Front wheel steering
Max. braking distance (no-load, stowed) (m)	1.5		

2. Main dimensions

Item	Parameter	Item	Parameter
Overall length (mm)	3110	Platform extension dimension (mm)	1520
Overall width (mm)	1790	Wheelbase (mm)	2290
Overall height (guardrail unfolded) (mm)	2580	Track width (mm)	1507
Overall height (guardrail folded) (mm)	1920	Min. ground clearance (mm)	230
Dimension of main platform (mm)	2790×1600	Tire specification (diameter × width) (mm)	Φ663×283

3. Engine system

Item	Parameter	Item	Parameter
Model	D1105-EF06e	Rated speed (r/min)	2500
Displacement (ml)	1123	Max. torque (Nm)	71.3
Rated power (kW)	15.7	Emission standard	EUV

4. Transmission system

Item	Parameter
Walking reducer	Rated output torque (Nm) 3390

	Speed ratio	48: 1
--	-------------	-------

5. Hydraulic system

Item		Parameter
Walking system	Type	Open
	Pump displacement (ml/r)	16
	Max. working pressure (MPa)	21
	Front motor displacement (ml/r)	375
	Rear motor displacement (ml/r)	25
Functional system	Type	Open
	Pump displacement (ml/r)	16
	Lifting system Max. working pressure (MPa)	20
	Steering system Max. working pressure (MPa)	21
	Floating system Max. working pressure (MPa)	21
	Outrigger system Max. working pressure (MPa)	-

6. Electrical system

Item		Parameter
Battery	Output voltage (V)	12
	Capacity (Ah)	80
Control system	Voltage (V)	12

7. Fluid filling amount

Item	Parameter	Item	Parameter
Hydraulic oil (L)	50	Engine antifreeze (L)	4
Walking reducer gear oil (L)	0.68×2	Fuel tank capacity (L)	53
Engine oil (L)	3.5		

2.1.2 Parameters of SR1018D off-road scissor lifting platform

1. Parameters of machine

Item	Parameter	Item	Parameter
Rated load (kg)	454	Fork lifting time (s)	39±4
Extended platform rated load (kg)	140	Fork lowering time (s)	46±4
Total weight (kg)	4330	Theoretical max. gradeability (no-load, stowed)	35%
Max. allowed workers (outdoor/indoor)	4/2	Max. outrigger leveling angle (from front to rear)	5.7° /5.5°
Max. working height (m)	11.7	Maximum outrigger leveling angle (from left to right)	12°
Max. platform height (m)	9.7	Max. allowed inclination	X-direction: left/right 2°
Max. travel height (m)	11.7		Y-direction: front/rear 3°
Min. turning radius (m)	4.75	Max. inner wheel	45°

		turning angle	
Max. travel speed (stowed) (km/h)	5.5±0.5	Max. allowed wind speed (m/s)	12.5
Max. travel speed (extended) (km/h)	0.5±0.2	Drive mode	Four-wheel drive Front wheel steering
Max. braking distance (no-load, stowed) (m)	1.5		

2. Main dimensions

Item	Parameter	Item	Parameter
Overall length (mm)	3760	Platform extension dimension (mm)	1520
Overall width (mm)	1790	Wheelbase (mm)	2290
Overall height (guardrail unfolded) (mm)	2550	Track width (mm)	1507
Overall height (guardrail folded) (mm)	1890	Min. ground clearance (mm)	230
Dimension of main platform (mm)	2790×1600	Tire specification (diameter × width) (mm)	Φ663×283

3. Engine system

Item	Parameter	Item	Parameter
Model	D1105-EF06e	Rated speed (r/min)	2500
Displacement (ml)	1123	Max. torque (Nm)	71.3
Rated power (kW)	15.7	Emission standard	EUV

4. Transmission system

Item	Parameter	
Walking reducer	Rated output torque (Nm)	3390
	Speed ratio	48: 1

5. Hydraulic system

	Item	Parameter
Walking system	Type	Open
	Pump displacement (ml/r)	16
	Max. working pressure (MPa)	21
	Front motor displacement (ml/r)	375
	Rear motor displacement (ml/r)	25
Functional system	Type	Open
	Pump displacement (ml/r)	16
	Lifting system	20
	Max. working pressure (MPa)	
	Steering system	21
	Max. working pressure (MPa)	
	Floating system	21
Max. working pressure (MPa)		
Outrigger system	18	
Max. working pressure (MPa)		

6. Electrical system

Item	Parameter	
Battery	Output voltage (V)	12
	Capacity (Ah)	80
Control system	Voltage (V)	12

7. Fluid filling amount

Item	Parameter	Item	Parameter
Hydraulic oil (L)	50	Engine antifreeze (L)	4
Walking reducer gear oil (L)	0.68×2	Fuel tank capacity (L)	53
Engine oil (L)	3.5		

2.1.3 Parameters of SR1218D off-road scissor lifting platform

1. Parameters of machine

Item	Parameter	Item	Parameter
Rated load (kg)	365	Fork lifting time (s)	61±4
Extended platform rated load (kg)	140	Fork lowering time (s)	55±4
Total weight (kg)	5080	Theoretical max. gradeability (no-load, stowed)	35%
Max. allowed workers (outdoor/indoor)	3/2	Max. outrigger leveling angle (from front to rear)	5.7° /5.5°
Max. working height (m)	13.9	Maximum outrigger leveling angle (from left to right)	12°
Max. platform height (m)	11.9	Max. allowed inclination	X-direction: left/right 2°
Max. travel height (m)	13.9		Y-direction: front/rear 3°
Min. turning radius (m)	4.75	Max. inner wheel turning angle	45°
Max. travel speed (stowed) (km/h)	5.5±0.5	Max. allowed wind speed (m/s/mpg)	12.5
Max. travel speed (extended) (km/h)	0.5±0.2	Drive mode	Four-wheel drive Front wheel steering
Max. braking distance (no-load, stowed) (m)	1.5		

2. Main dimensions

Item	Parameter	Item	Parameter
Overall length (mm)	3760	Platform extension dimension(mm)	1520
Overall width (mm)	1790	Wheelbase (mm)	2290
Overall height (guardrail unfolded) (mm)	2700	Track width(mm)	1507
Overall height (guardrail folded) (mm)	2040	Min. ground clearance (mm)	230
Dimension of main platform (mm)	2790×1600	Tire specification (diameter × width) (mm)	Φ663×283

3. Engine system

Item	Parameter	Item	Parameter
Model	D1105-EF06e	Rated speed (r/min)	2500
Displacement (ml)	1123	Max. torque (Nm)	71.3
Rated power (kW)	15.7	Emission standard	EUV

4. Transmission system

Item	Parameter	
Walking reducer	Rated output torque (Nm)	3390
	Speed ratio	48: 1

5. Hydraulic system

Item	Parameter	
Walking system	Type	Open
	Pump displacement (ml/r)	16
	Max. working pressure (MPa)	21
	Front motor displacement (ml/r)	375
	Rear motor displacement (ml/r)	25
Functional system	Type	Open
	Pump displacement (ml/r)	16
	Lifting system	20
	Max. working pressure (MPa)	21
	Steering system	21
	Max. working pressure (MPa)	21
	Floating system	21
Max. working pressure (MPa)	18	

6. Electrical system

Item	Parameter	
Battery	Output voltage (V)	12
	Capacity (Ah)	80
Control system	Voltage (V)	12

7. Fluid filling amount

Item	Parameter	Item	Parameter
Hydraulic oil (L)	50	Engine antifreeze (L)	4
Walking reducer gear oil (L)	0.68×2	Fuel tank capacity (L)	53
Engine oil (L)	3.5		

2.2 Specification for selection of tightening torque of the lifting platform

The tightening torque tolerance range is 10% for all hydraulic seals, important transmission connectors and key processes with defined torque tightening requirements, and 20% for non-essential reference torques, which is to be rounded to the nearest integer when necessary.

Table 1: Tightening torque of metric/imperial-threaded fittings and plugs (unit: N.m)

Tightening torque of metric-threaded oil ports					Tightening torque of imperial-threaded oil ports				
Pipe diameter	Thread specification (mm)	Fitting type		Plug VSTI-E	Pipe diameter	Thread specification (Inch)	Fitting type		Plug VSTI-ED
		Type E	Type F				Type E	Type F	
6L	M10X1.0	27	22	16	6L	G1/8A	22	16	16
8L	M12X1.5	37	32	27	8L	G1/4A	37	32	32
10L	M14X1.5	58	48	37	10L	G1/4A	37	32	/
12L	M16X1.5	75	58	58	12L	G3/8A	75	58	63
15L	M18X1.5	95	75	70	15L	G1/2A	120	95	85
18L	M22X1.5	140	115	95	18L	G1/2A	120	95	/
22L	M28X2.0	190	160	140	22L	G3/4A	190	160	140
28L	M33X2.0	325	220	235	28L	G1A	325	220	210
35L	M42X2.0	470	295	380	35L	G1 1/4A	470	315	470
42L	M48X2.0	565	380	/	42L	G1 1/4A	565	380	470
6S	M12X1.5	42	37	/	6S	G1/4A	42	37	/
8S	M14X1.5	53	48	/	8S	G1/4A	42	37	/
10S	M16X1.5	75	58	/	10S	G3/8A	85	63	/
12S	M18X1.5	95	75	/	12S	G3/8A	85	63	/
14S	M20X1.5	130	85	/	14S	G1/2A	120	95	/
16S	M22X1.5	140	105	/	16S	G1/2A	120	95	/
20S	M27X2.0	190	180	/	20S	G3/4A	190	160	/
25S	M33X2.0	325	325	/	25S	G1A	325	220	/
30S	M42X2.0	470	345	/	30S	G1 1/4A	470	315	/
38S	M48X2.0	565	440	/	38S	G1 1/2A	565	380	/

Table 2: tightening torque of UN-threaded fittings and plugs (unit: N.m)

Product Series	Thread UN/UNF	Non-directional assembly torque N.m	Non-directional assembly torque N.m
EO-L	7/16-20 UN(F)	23	18
	1/2-20 UN(F)	28	28
	9/16-18 UN(F)	34	34
	3/4-16 UN(F)	60	55
	7/8-14 UN(F)	115	80
	1-1/16-12 UN(F)	140	100
	1-5/16-12 UN(F)	210	150
	1-5/8-12 UN(F)	290	290
1-7/8-12 UN(F)	325	325	
EO-S	7/16-20 UN(F)	20	20
	1/2-20 UN(F)	40	40
	9/16-18 UN(F)	46	46
	3/4-16 UN(F)	80	80
	7/8-14 UN(F)	135	135
	1-1/16-12 UN(F)	185	185
	1-5/16-12 UN(F)	270	270
	1-5/16-12 UN(F)	270	270
	1-5/8-12 UN(F)	340	340
1-7/8-12 UN(F)	415	415	

Description:

1. Table 1 gives the torques for metric-threaded joints and inch-threaded joints, and Table 2 gives the torques for UN-threaded joints, and for those torques, an error of +10% is allowed;
2. The torque values given in Table 1 and Table 2 are based on the condition that the connected part is made of steel, and for connected part made of aluminum, the tightening torque equal to 60% of the corresponding torque in Table 2 and Table 3 shall apply and shall be rounded to the nearest integer

after calculation;

3. For Parker joints, the torque is to be selected according to the name and specification, and for ordinary joints, the torque is to be selected according to the thread specification.

For example:

1) GE 28 L M ED OMD A3C: GE for straight-through joint, 28 for pipe diameter, L for normal pressure, M for metric thread, ED for E-type elastic seal, OMD for no nut sleeve, A3C for galvanizing; According to the 28L M ED, the torque value can be selected from Table 1: 325N.m

2) GE O 22L R 3/4 OMDA3C: O represents the F-type O-ring seal, R represents the inch thread, and 3/4 represents the thread specification G3/4; According to O 22L R3/4, the torque value can be selected from Table 2: 160N.m;

3) GE O 20 S R OMDCF: S represents the heavy pressure, and the torque value selected according to O 20 S R is: 160 N.m;

Table 3: Tightening Torque of Metric-Threaded Swivel Nuts (unit: N.m)

Pipe diameter	Thread specifications	Tightening torque	Pipe diameter	Thread specifications	Tightening torque N•m
06L	M12X1.5	16	06S	M14X1.5	27
08L	M14X1.5	22	08S	M16X1.5	42
10L	M16X1.5	32	10S	M18X1.5	53
12L	M18X1.5	42	12S	M20X1.5	63
15L	M22X1.5	58	14S	M22X1.5	80
18L	M26X1.5	90	16S	M24X1.5	85
22L	M30X2	115	20S	M30X2	125
28L	M36X2	135	25S	M36X2	180
35L	M45X2	220	30S	M45X2	260
42L	M52X2	345	38S	M52X2	370

Description:

- 1) For torques given in Table 2, an error of +10% is allowed;
- 2) The torque values given in Table 3 are based on the condition that the connected part is made of steel, and for connected part made of aluminum, the tightening torque equal to 60% of the corresponding torque in Table 1 shall apply and shall be rounded to the nearest integer after calculation;
- 3) For Parker rubber hoses, right-angle joints and tee joints, the torque is to be selected according to the name and specification, and for ordinary rubber hoses, right-angle joints and tee joints, the torque is to be selected according to the thread specification.

For example:

- 1) F481 CACF 2815 16: F481 for crimping form and hose type, CACF for joint type at both ends, CA for 24° conical swivel nut with O-ring, CF for 90° elbow of 24° conical swivel nut with O-ring, and 2815 for connection specification of joint at both ends of hose. According to this, the torque selected for end 28 is 135N.m, and the torque selected for end 15 is 58N.m;
- 2) F412 SN CACF 1210 06: SN represents heavy pressure hose, the torque at end 12 is 63 N.m,

and the torque at end 10 is 53 N.m;

- 3) EW15LOMDA3C: EW represents a right-angle combination fitting. The torque value selected from Table 1 according to 15L is 32 N.m.

Table 4: Tightening torque of ordinary bolts (unit: N.m)

Strength grade of bolt	Yield strength N/MM ²	Nominal diameter of bolt mm				
		6	8	10	12	14
		Tightening torque N·m				
4.6	240	4~5	10~12	20~25	36~45	55~70
5.6	300	5~7	12~15	25~32	45~55	70~90
6.8	480	7~9	17~23	33~45	58~78	93~124
8.8	640	9~12	22~30	45~59	78~104	124~165
10.9	900	13~16	30~36	65~78	110~130	180~210
12.9	1080	16~21	38~51	75~100	131~175	209~278
Strength grade of bolt	Yield strength N/MM ²	Nominal diameter of bolt mm				
		16	18	20	22	24
		Tightening torque N·m				
4.6	240	90~110	120~150	170~210	230~290	300~377
5.6	300	110~140	150~190	210~270	290~350	370~450
6.8	480	145~193	199~264	282~376	384~512	488~650
8.8	640	193~257	264~354	376~502	521~683	651~868
10.9	900	280~330	380~450	540~650	740~880	940~1120
12.9	1080	326~434	448~597	635~847	864~1152	1098~1464
Strength grade of bolt	Yield strength N/MM ²	Nominal diameter of bolt mm				
		27	30	33	36	39
		Tightening torque N·m				
4.6	240	450~530	540~680	670~880	900~1100	928~1237
5.6	300	550~700	680~850	825~1100	1120~1400	1160~1546
6.8	480	714~952	969~1293	1319~1759	1694~2259	1559~2079
8.8	640	952~1269	1293~1723	1759~2345	2259~3012	2923~3898
10.9	900	1400~1650	1700~2000	2473~3298	2800~3350	4111~5481
12.9	1080	1606 ~ 2142	2181 ~ 2908	2968~3958	3812~5082	4933~6577

3 Service

3.1 Platform

The working platform of the off-road scissor lifting platform is mainly composed of main platform, extended platform, guardrail assembly, semi-swing gate and etc. The exploded view of the working platform is shown in the Fig. below:

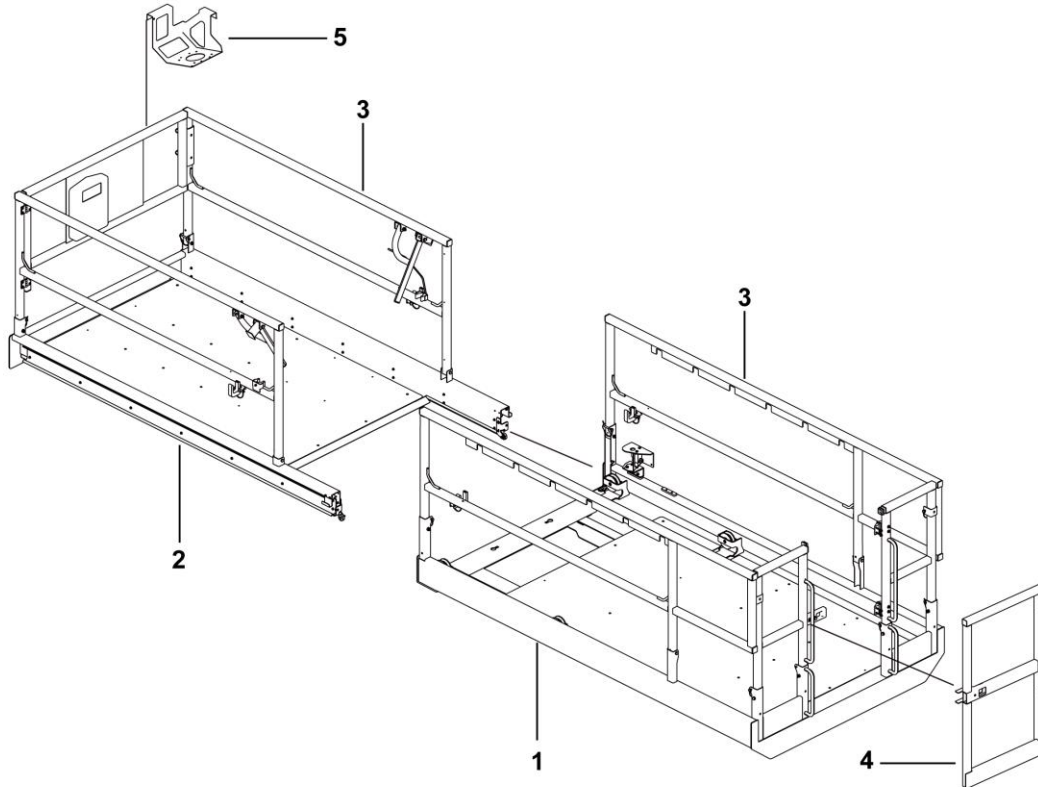

Fig. 3.1 Platform

1. Main platform 2. Extended platform 3. Guardrail assembly 4. Semi-swing gate 5. Support

3.1.1 Removing the working platform

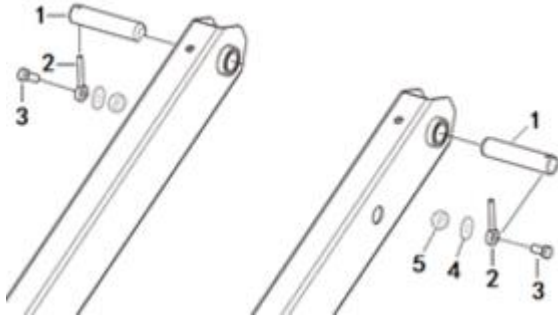

Fig. 3.2 Connection between fork and platform

1.Pin 2.Safety pin 3.bolt 4.washer 5.nut

1. Drive the lifting platform to a safe area (with safe operation space available around it, and without fork lifting interference point above it).
2. Pull out the connector between the PCU assembly and the fork PCU harness.
3. Pull the PCU harness out of the platform and put it on the side of the fork (ensure that the harness will not be pressed when the platform is being lifted).
4. As shown above, remove the connecting pin between the main platform and the fork with a special tool.
5. Attach the platform assembly to the sling of traveling crane, and ensure that the sling is connected firmly and reliably. Pass the sling from the inside of the sling fixing point of the guardrail assembly.

Caution:

Lift the platform through the two anchor points on the guardrails on both sides, and lifting by one sling is not allowed.

6. Adjust the traveling crane, and remove the sliders on both sides from the lower bend plate of the main platform.
7. Adjust the position of sling, and lift the platform assembly smoothly to separate it from the fork. Then, place the platform assembly on a structure with sufficient

supporting capacity.

3.1.2 Removing the extended platform

Caution:

Only when the platform is in the stowed position and the extended platform is fully retracted and locked in place can this operation be performed.

1. Extend the extended platform by about 1 m.
2. Support the extended platform with a lifting equipment. Do not apply any lifting force.
3. Undo the fasteners on each wheel carrier of the platform, and remove the wheel carrier from the machine.
4. Remove the platform pulley from the machine.
5. Carefully slide the extended platform off the platform, and place it on a structure with sufficient supporting capacity.

CAUTION: Risk of crushing.

If not properly supported and secured during removal, the extended platform may be out of balance and fall off.

3.1.3 Subassembling the extended platform

1. Hoist part 1 to tooling with sling, and be careful during the hoisting.
2. Install the base plate (2) on the extended platform weldment (1) with blind rivets (3), and fix the four corners of each base plate with parts 4, 5 and 6.

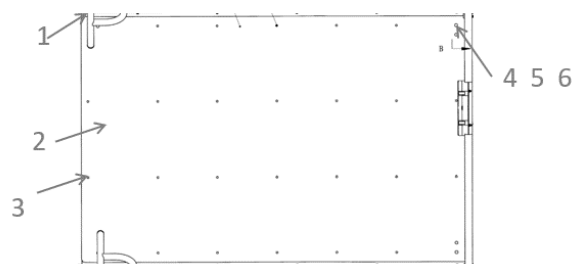

Fig. 3.3 Extended platform floor

1. Extended platform base plate weldment
2. Extended platform base plate
3. Blind rivet
4. Bolt
5. Nut
6. Washer

Reference tightening torque of part 4: $12 \pm 1 \text{N.m}$

Tools: socket wrench 10, torque wrench QSP25N3, open-end ratchet wrench 10-10, pneumatic riveting gun.

CAUTION:

The shank of the blind rivet shall not be higher than aluminum plate.

3. Assemble part 7 to part 1 with parts 8 and 9, and tighten it;
4. Assemble parts 10 and 13 on both sides of the extended platform with parts 5, 6, 11 and 12, and tighten them;
5. After the limit plate is installed, ensure that the roller comes in contact with the bottom surface of the platform without suspension. Make a mark after tightening.

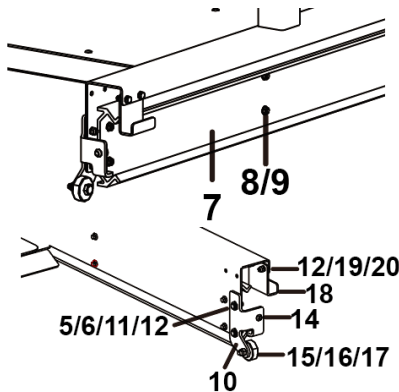

Fig. 3.4 Subassembling the extended platform

7. Guide rail
8. Bolt
9. Nut
10. Left limit plate
11. Washer
12. Bolt
13. Right limit plate
14. Rivet pin
15. Roller
16. Nut
17. Step bolt
18. Bend plate
19. Washer
20. Nut

Reference tightening torque of parts 8 and 12: $12 \pm 1 \text{N.m}$, Reference tightening torque of part 16: $28 \pm 3 \text{N.m}$;

Tools: socket wrench 10, torque wrench QSP25N3, open-end wrench 8-10, ratchet wrench QSP50N3, hexagon head socket

wrench M8

6. Assemble part 14 to part 10 and part 13 as shown;
7. Assemble part 15 to parts 10 and 13 with parts 16 and 17, and tighten it;
8. Assemble the part 18 to the left and right sides of extended platform weldment with parts 19, 20 and 12 as shown, and tighten it; make a mark after tightening.

3.1.4 The main platform assembly

1. First, insert the sliders on both sides of the fork into the openings below the platform, and then push the platform to make the platform fall on the fork;

CAUTION: Before lowering the platform, determine the front and rear ends of the platform to avoid reverse installation;

2. Fix the platform on the fork with parts 1, 2 and 3, and tighten it to the specified torque;

CAUTION: The two parts 1 on the top shall be installed from under the extended platform with appropriate carefulness exerted.

CAUTION: After the slider is clamped into the platform, it is necessary to check the gap between the slider and the edge of the platform slideway, and if the gap is greater than 1mm, use parts 4 and 5 to adjust the gap. Ensure that the adjustments on both sides are uniform, and adjustment on one side only is not allowed.

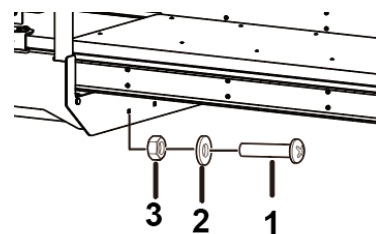

Fig. 3.5 Platform assembly

1. Bolt
2. Washer
3. Nut

Tightening torque of part 1: $90 \pm 9 \text{N.m}$

Tools: ratchet torque QSP200, socket wrench 1/2 18

3.1.5 Folding the working platform guardrail

The SR0818D/SR1018D/SR1218D platform guardrail system consists of the extension platform folding guardrail and the main platform folding guardrail, which are fixed in place by D-pins.

1. Lower the platform completely and lock the extension platform.
2. Remove the platform control unit;
3. Remove the guide block between the main platform guardrail and the extension platform guardrail from the inside of the platform, and place it in the platform;
4. Remove the two D-pins at the front part of extension platform from the inside of the platform.
5. Turn the front guardrail of the extension platform inward always with hands not putting on the places with risk of pinching, and meanwhile, prevent the left and right guardrails of the extension platform from overturning;
6. Install the two removed D-pins back to the guardrail bracket on each side;
7. Turn the left guardrail of the extension platform inward always with hands not putting on the places with risk of pinching, and meanwhile, prevent the right guardrail of the extension platform from overturning;
8. Turn the right guardrail of the extension platform inward always with hands not putting on the places with risk of pinching;
9. Remove the two D-pins on the upper part of the main platform door guardrail;
10. Push the door guardrail inward from the ladder or the ground always with hands not putting on the places with risk of pinching, and meanwhile, prevent the left and right guardrails of the main platform from

overturning;

11. Push the left guardrail of the main platform inward from the ladder or the ground always with hands not putting on the places with risk of pinching, and meanwhile prevent the left and right guardrails of the main platform from overturning; push the right guardrail of the main platform inward from the ladder or the ground always with hands not putting on the places with risk of pinching;
12. Install the two removed D-pins back to the guardrail on each side.

3.2 Platform control unit (PCU)

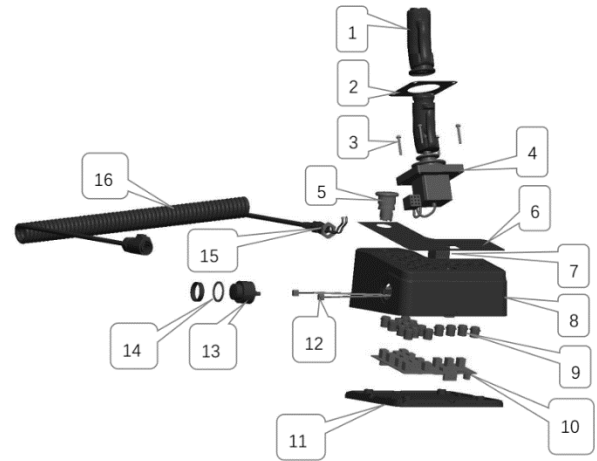

Fig. 3.6 PCU

S/N	Name
1	Joystick silicone boot
2	Joystick direction sticker
3	Hexagon socket flat round head screw
4	PCU joystick assembly
5	Emergency stop switch
6	PCU film (American standard)
7	Joystick adapter harness assembly
8	PCU housing
9	Switch key cap
10	PCBA
11	PCU base
12	Buzzer harness
13	Buzzer
14	Buzzer sealing gasket
15	Spring harness plastic nut
16	Spring harness

3.2.1 Removing the platform control unit

1. As shown below, remove the bolts to separate the bracket from the PCU, and disconnect the

PCU harness from the ground control unit to remove the PCU.

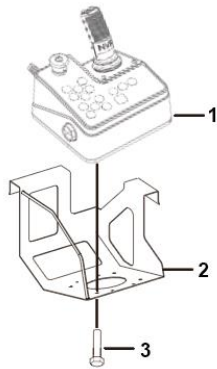

Fig. 3.7 platform control unit

1. PCU 2. PCU bracket welded 3. Bolt

2. Removing the platform circuit board

(1) Loosen the fasteners for fixing the PCU cover. Open the PCU cover.

(2) Visually locate the circuit board installed on the inside of the PCU cover.

(3) Fix the PCU cover in a horizontal position.



WARNING: Risk of electric shock/ burning.

The contact with a live circuit may result in death or serious personal injury. Be sure to remove the ring, watch and other ornaments.



CAUTION: Risk of part damage.

Electrostatic discharge can damage circuit board components. Therefore, when performing any operation to the circuit board, keep a firm contact with the metal part on the machine that is always grounded, or use a grounded wristband.

(4) Mark and disconnect the harness connectors on the PCU circuit board.

(5) Carefully remove the fasteners for fixing the PCU circuit board.

(6) Carefully remove the circuit board from the

PCU.

3.2.2 Assembling the platform control unit (PCU)

1. As shown in Fig. 3.7, install the PCU (part 1) onto the bracket (part 2), and tighten it with bolt (part 3).
2. Fix the PCU harness at the bracket.
3. Connect the connector of the PCU assembly to the PCU harness connector and install it firmly.

3.3 The platform gate

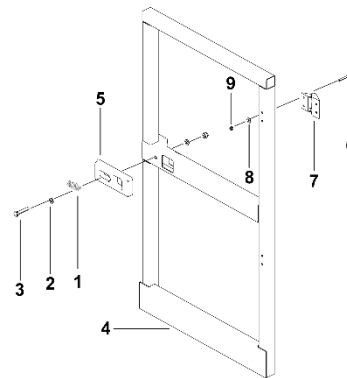

Fig. 3.8 The platform gate

1. Spring 2. Washer 3. Bolt 4. Swing gate weldment 5. Plastic block 6. Bolt 7. Hinge 8. Washer 9. Nut

3.3.1 Removing the semi-swing gate

1. As shown above, remove the fastener for fixing part 7 on the gate, remove the spring hinge (7), and slowly take down the swing gate from the guardrail.
2. Undo the fasteners such as bolts (3), and remove plastic block (5) and spring (1).

3.3.2 Installing the semi-swing gate

1. Install the plastic block (5) and spring (1) into swing gate and tighten them with bolts and washers. Pay attention that the plastic block is to be slightly tightened so that it can slide smoothly.
2. Fix the semi-swing gate on the platform with the spring hinge (7), and tighten it with parts

9, 6 and 8.

3. During assembling, keep the lower edge of the gate in parallel with the main platform base plate, and open and close the gate to check that it operates smoothly without seizure, and check that the gate, after being opened, can spring back to its original position freely and can be locked properly and limited reliably. After the installation is completed, check that the swing gate swings smoothly without seizure.

3.4 Fork assembly

3.4.1 Removing forks(SR0818D)

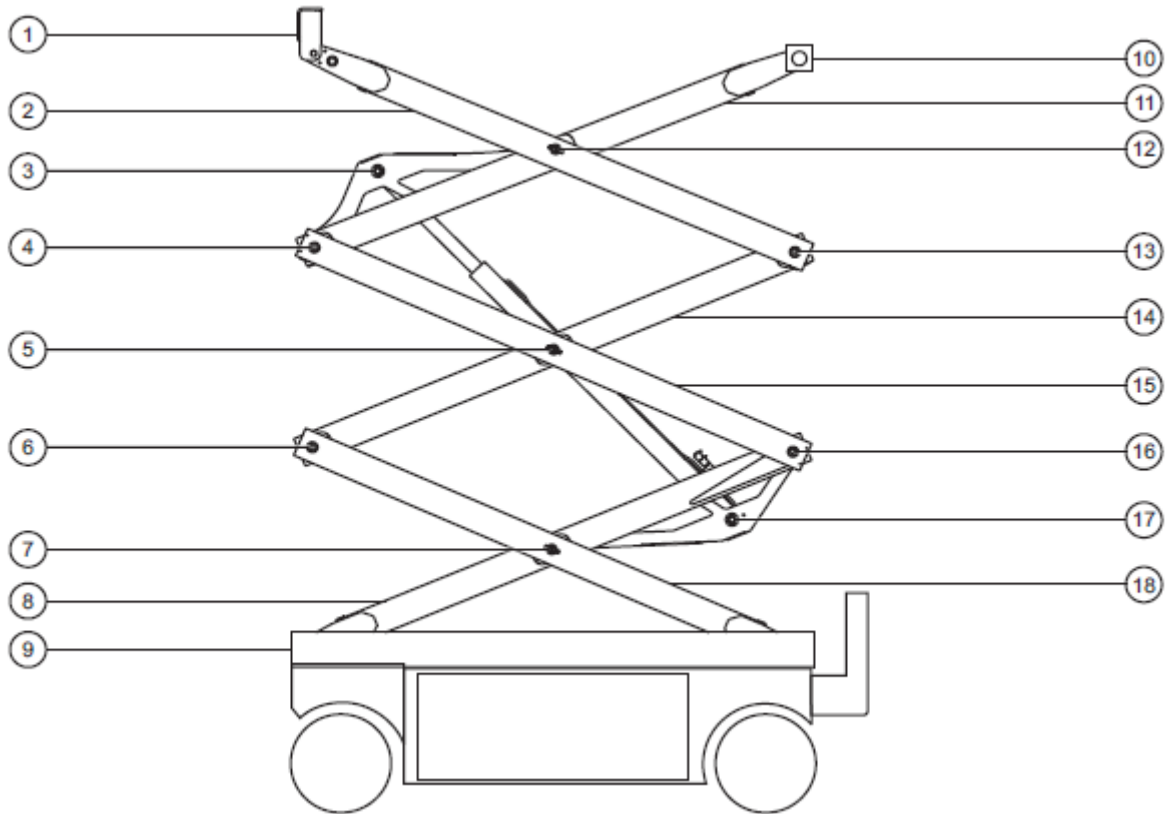

Fig. 3.9 SR0818D Fork assembly

- | | |
|------------------------------|--------------------------------|
| 1. Platform pin | 10. Slider |
| 2. Third outer arm | 11. Third inner arm |
| 3. Lift cylinder rod end pin | 12. 3# center pin |
| 4. 3# pin (steering end) | 13. 3# pin |
| 5. 2# pin (steering end) | 14. Second inner arm |
| 6. 2# pin | 15. Second outer arm |
| 7. 1# center pin | 16. 2# pin (non-steering end) |
| 8. First inner arm | 17. Lift cylinder tube end pin |
| 9. Chassis pin | 18. First outer arm |

 **WARNING: Danger of injury**

This procedure requires specific maintenance skills, lifting equipment and a suitable workshop. Carrying out this process without these skills and tools may result in death or serious injury, as well as serious component damage. Therefore, it is strongly recommended that this service is performed by dealers.

 **CAUTION:**

The O-ring (if any) of the removed fitting and/or hose assembly must be replaced. During installation, all connections must be tightened to specified torque. Please refer to the specification for selection of tightening torque of the lifting platform.

1. Remove the platform.
2. Support and attach the access ladder to an appropriate lifting equipment, remove the fasteners from the access ladder, and then remove the access ladder from the machine.
3. Remove the cables and harnesses from the wiring ring of the third outer arm.

 **CAUTION: Risk of part damage**

If being kinked or squeezed, the cables may be damaged.

4. Remove the cable harness from the wiring boards of the second to third forks.
5. Attach the sling of the traveling crane to the third outer arms on the left and right sides of the machine.
6. Remove the outer retaining rings, washers and fasteners that fix the 3# center pins on the left and right sides of the machine.
7. Remove the 3# center pin on both sides using a soft metal hammer, and remove the wiring boards of second to third forks.

8. Remove the fasteners that fix the 3# pin from the non-steering end of the machine.
9. Remove the 3# pin on left and right sides from the non-steering end of the machine using a soft metal hammer.
10. Remove the third outer arm from the machine.

 **WARNING: Risk of crushing.**

If not properly supported during removal, the third outer arms on the left and right sides may be out of balance and fall off.

11. Mark, disconnect and plug the hydraulic hose of upper lift cylinder, and cover the fittings on the cylinder.
12. Mark and disconnect the harness of the cylinder valve block.
13. Attach the sling of the traveling crane to the lower lift cylinder rod end.

 **WARNING: Risk of personal injury**

If not properly supported during removal of cylinder rod end shaft, the cylinder may fall off.

14. Remove the fasteners that fix the lift cylinder rod end pin.
15. Remove the upper lift cylinder rod end pin from the machine using a soft metal hammer.

 **WARNING: Risk of crushing.**

If not properly supported during removal of cylinder rod end pin, the cylinder may fall off.

16. Attach the sling of the traveling crane to the third inner arm.
17. Remove the fasteners that fix the 3# pin from the steering end of the machine.
18. Remove the 3# pin from the steering end of

the machine using a soft metal hammer.

Remove the third inner arm from the machine.

19. Attach the sling of the traveling crane to the second outer arms on the left and right sides of the machine.
20. Remove the fasteners that fix the 2# center pins on left and right sides of the machine.
21. Remove the 2# center pins on the left and right sides of the machine using a soft metal hammer. And remove the wiring boards of first to second forks.
22. Remove the fasteners that fix the 2# pins on the left and right sides from the non-steering end of the machine. Remove the second outer arms on the left and right sides from the machine.



WARNING: Risk of crushing.

If not properly supported during removal, the third outer arms on the left and right sides may be out of balance and fall off.

23. Attach the sling of the traveling crane to the second inner arm.
24. Remove the fasteners that fix the 2# pins on the left and right sides from the steering end of the machine.
25. Remove the 2# center pins on the left and right sides of the machine using a soft metal hammer. Remove the second inner arm from the machine.



WARNING: Risk of crushing.

If not properly supported during removal, the second inner arm may be out of balance and fall off.

26. Attach the sling of the traveling crane to the first inner arm.



WARNING: Risk of personal injury

When the fork is being lowered to the safety arm, keep your hand away from the moving parts.

27. Attach the sling of the traveling crane to the lift cylinder rod end.



WARNING: Risk of personal injury

Splashed hydraulic oil will penetrate and burn the skin. Therefore, please loosen hydraulic connectors very slowly to reduce the oil pressure gradually. Prevent the oil from spraying or ejection.

28. Lift the lift cylinder to a vertical position.
29. Remove the fasteners that fix the pin from the lift cylinder tube end shaft. Remove the pin using a soft metal hammer. Remove the lift cylinder from the machine.



WARNING: Risk of crushing.

If not properly supported and fixed to the lifting equipment, the lift cylinder may be out of balance and fall off.



CAUTION: Risk of part damage

When removing the cylinder from the machine, be careful not to damage the valve or joint on the cylinder.

30. Remove the cable from the wiring ring of the first arm and set it aside.



CAUTION: Risk of part damage

If being kinked or squeezed, the cables may be damaged.

31. Support the ladder and attach it to an appropriate lifting equipment.



WARNING: Risk of crushing.

If not properly supported and fixed to the lifting equipment, the ladder may fall off.

32. Attach the sling of the traveling crane to the first outer arm. Do not apply any lifting force.
33. Remove the outer snap ring and fasteners that fix the 1# center pin.
34. Remove the 1# center pins on both sides using a soft metal hammer.



WARNING: Risk of personal injury

If not properly supported during removal of pin, the first outer arm may be out of balance and fall off.

35. Slide the first outer arm to the non-steering end and remove it from the machine.
36. Attach the sling of the traveling crane to the first inner arm. Do not lift it.
37. Remove the fasteners that fix the pin for connecting the first inner arm to the end of the chassis. Remove the pin.
38. Remove the first inner arm from the machine.

3.4.2 Removing forks (SR1018D)

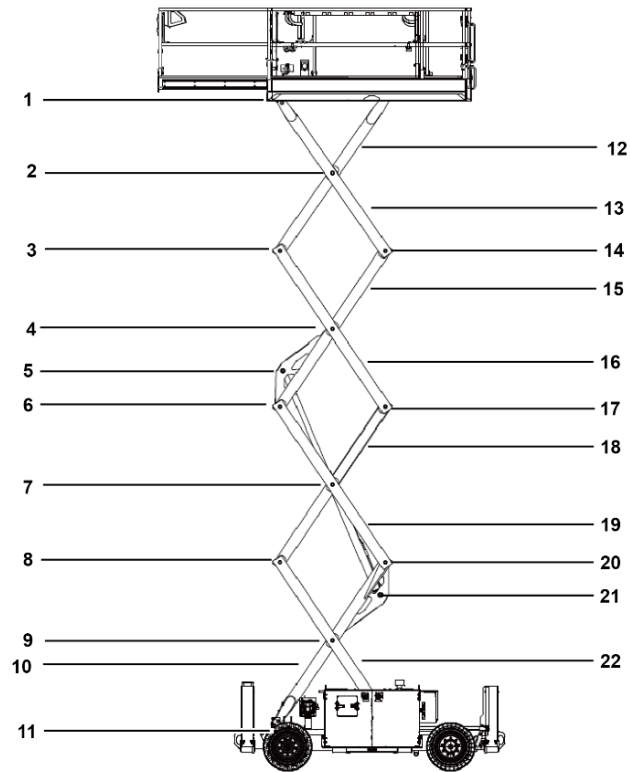

Fig. 3.10 SR1018D Fork assembly

- | | |
|---------------------------------|--|
| 1. 5# pin | 12. Fourth inner arm |
| 2. 4# center pin | 13. Fourth outer Arm |
| 3. 4# pin (steering end) | 14. 4# pin (non-steering end) |
| 4. 3# center pin | 15. Third inner arm |
| 5. Lower cylinder rod end shaft | 16. Third outer Arm |
| 6. 3# pin (steering end) | 17. 3# pin (non-steering end) |
| 7. 2# center pin | 18. Second inner arm |
| 8. 2# pin (steering end) | 19. Second outer Arm |
| 9. 1# center pin | 20. 2# pin (non-steering end) |
| 10. First inner arm | 21. Lower lift cylinder barrel end shaft |
| 11. 1# pin | 22. First outer Arm |

**WARNING: Danger of injury**

This procedure requires specific maintenance skills, lifting equipment and a suitable workshop. Carrying out this process without these skills and tools may result in death or serious injury, as well as serious component damage. Therefore, it is strongly recommended that this service is performed by dealers.

**Caution:**

The O-ring (if any) of the removed fitting and/or hose assembly must be replaced. During installation, all connections must be tightened to specified torque. Please refer to the specification for selection of tightening torque of the lifting platform.

1. Remove the platform.
2. Remove the cables and harnesses from the wiring ring of the fifth outer arm and the wiring plate of the fifth inner arm, and set them aside.

**CAUTION: Risk of part damage**

If being kinked or squeezed, the cables may be damaged.

3. Remove the cables and harnesses from the wiring board of fourth inner arm and set them aside.
4. Attach the sling on the traveling crane to the fourth outer arm on the left and right sides of the machine.
5. Remove the fasteners that fix the 4# center pin on the fuel tank side of the machine.
6. Remove the wiring board of fourth inner arm.
7. Remove the fasteners that fix the 4# center pin on the engine case side of the machine.
8. Remove the 4# center pins on both sides using a soft metal hammer.

9. Remove the fasteners that fix the 4# pin from the non-steering end of the machine.
10. Remove the 4# pin from the non-steering end of the machine using a soft metal hammer.
11. Remove the fourth outer arm from the machine

**WARNING: Risk of crushing**

If not properly supported during removal, the fourth outer arm may be out of balance and fall off.

12. Attach the sling of the traveling crane to the fourth inner arm.
13. Remove the fasteners that fix the 4# pin.
14. Remove the 4# pin from the steering end using a soft metal hammer. Remove the fourth inner arm from the machine.
15. Remove the cables and harnesses from the wiring board and the wiring ring of third inner arm and set them aside.

**CAUTION: Risk of part damage**

If being kinked or squeezed, the cables may be damaged.

16. Attach the sling of the traveling crane to the third outer arm on the fuel tank side.
17. Remove the fasteners that fix the 3# center pin on the fuel tank side.
18. Remove the wiring board of the third arm, and take it down from the machine.
19. Remove the 3# center pin on the ground control unit side using a soft metal hammer.
20. Knock out the 3# pin at the non-steering end of the machine by a half using a soft metal hammer.
21. Remove the third outer arm on the ground control unit side.

**WARNING: Risk of crushing**

If not properly supported during removal, the third outer arm may be out of balance and fall off.

22. Attach the sling of the traveling crane to the third outer arm on the engine case side.
23. Remove the 3# center pin on the engine case side of the machine using a soft metal hammer.
24. Tap the 3# pin on the other side using a soft metal hammer to remove the third outer arm.

**WARNING: Risk of crushing**

If not properly supported during removal, the third outer arm may be out of balance and fall off.

25. Remove the 3# pin from the non-steering end of the machine using a soft metal hammer.
26. Attach the sling of the traveling crane to the lift cylinder rod end without applying any lifting pressure.
27. Remove the fasteners that fix the lift cylinder rod end shaft from the machine. Remove the pin using a soft metal hammer.

**WARNING: Risk of personal injury.**

If not properly supported during removal of cylinder rod end shaft, the cylinder may fall off.

28. Lower the cylinder to the first inner arm.
29. Attach the sling of the traveling crane to the third inner arm.
30. Remove the fasteners that fix the 3# pin at the steering end.
31. Remove the 3# pin using a soft metal hammer.
32. Remove the third inner arm from the machine.

**WARNING: Risk of crushing**

If not properly supported during removal, the third inner arm may be out of balance and fall off.

33. Remove the fasteners that fix the 2# center pin on the fuel tank side.
34. Remove the cables and harnesses from the wiring board and the wiring ring of second arm and set them aside.
35. Remove the wiring board of second arm from the machine.
36. Attach the sling of the traveling crane to the second outer arm on the fuel tank side.
37. Remove the 2# center pin on the fuel tank side using a soft metal hammer.
38. Remove the fasteners that fix the 2# pin at the non-steering end of the machine.
39. Knock out the 2# pin at the non-steering end of the machine by a half using a soft metal hammer, and then remove the second outer arm on the ground control unit side.
40. Attach the sling of the traveling crane to the second outer arm on the engine case side.
41. Remove the fasteners that fix the 2# center pin (7) on the engine case side.
42. Remove the 2# center pin on the engine case side using a soft metal hammer.
43. At the non-steering end of the machine, tap the 2# pin on the other side using a soft metal hammer, and then remove the second outer arm on the engine case side.

**WARNING: Risk of personal injury.**

If not properly supported during removal, the second outer arm on the ground control unit side may be out of balance and fall off.

44. Remove the 3# pin at the non-steering end of the machine.
45. Attach the sling of the traveling crane to the

second inner arm.

46. Remove the fasteners that fix the 2# pin at the steering end of the machine.
47. Remove the 2# pin using a soft metal hammer. Remove the second inner arm from the machine.

! WARNING: Risk of crushing

If not properly supported during removal, the second inner arm may be out of balance and fall off.

48. Remove the protective arm from the second inner arm that has just been removed.

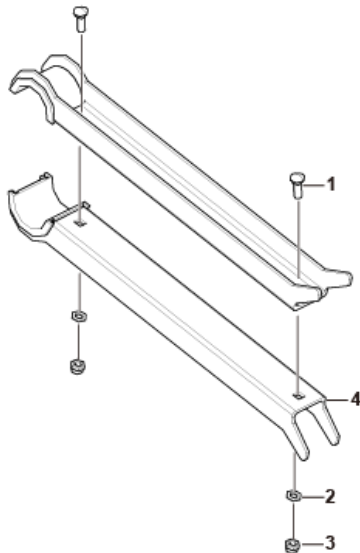

Fig. 3.11 Assembling diagram of protective arm

1. Bolt 2. Washer 3. Nut 4. Bend plate assembly
49. Attach the sling of the traveling crane to the first inner arm.
50. Lift the first inner arm by about 60cm, and support the safety arm between the first inner arm and the first outer arm at the non-steering end of the machine. Lower the fork to the safety arm.

! WARNING: Risk of personal injury.

When the fork is being lowered to the safety arm, keep your hand away

from the moving parts.

51. Attach the sling of the traveling crane to the lift cylinder rod end. Lift the lift cylinder by about 1m.
52. Mark, disconnect and plug the hydraulic hose of the lift cylinder. Cover the fittings on the cylinder.

! WARNING: Risk of personal injury.

Splashed hydraulic oil will penetrate and burn the skin. Therefore, please loosen hydraulic connectors very slowly to reduce the oil pressure gradually. Prevent the oil from spraying or ejection.

53. Mark and disconnect the harness on the cylinder valve.
54. Lift the lift cylinder to a vertical position.
55. Remove the fasteners that fix the pin from the lift cylinder tube end shaft. Remove the pin using a soft metal hammer.
56. Remove the lift cylinder from the machine.

! WARNING: Risk of crushing

If not properly supported and fixed to the lifting equipment, the lift cylinder may be out of balance and fall off.

! CAUTION: Risk of part damage

When removing the cylinder from the machine, be careful not to damage the valve or joint on the cylinder.

57. Place a 10cm x 10cm x 1.2m cushion block under the 1# center pin across both sides of the chassis.
58. Attach the sling of the traveling crane to the first inner arm at the non-steering end. Lift the first inner arm and remove the safety arm. Place the first inner arm on the cushion block

placed on the chassis.

59. Remove the cable from the wiring ring of the first arm and set it aside.



CAUTION: Risk of part damage

If being kinked or squeezed, the cables may be damaged.

60. Support the ladder and attach it to an appropriate lifting equipment.



WARNING: Risk of crushing

If not properly supported and fixed to the lifting equipment, the ladder may fall off.

61. Remove the fasteners from the ladder, and then remove the ladder from the machine.
62. Attach the sling of the traveling crane to the first outer arm. Do not apply any lifting force.
63. Remove the fasteners that fix the 1# center pin.
64. Remove the 1# center pins on both sides using a soft metal hammer.



WARNING: Risk of personal injury.

If not properly supported during removal of pin, the first outer arm may be out of balance and fall off.

65. Slide the first outer arm to the non-steering end and remove it from the machine.
66. Attach the sling of the traveling crane to the first inner arm. Do not lift it.
67. Remove the fasteners that fix the travel switch cover on the first inner arm, and remove the cover.
68. Disconnect the connecting wires of upper and lower limit travel switches, and remove the travel switch and the travel switch mounting plate.
69. Remove the fasteners that fix the pin for

connecting the first inner arm to the end of the chassis. Remove the pin.

70. Remove the first inner arm from the machine.



CAUTION: Risk of part damage

Be careful not to damage the limit switch when removing the first inner arm from the machine.



WARNING: Risk of personal injury.

If not properly supported during removal of first inner arm from the machine, the first outer arm may be out of balance and fall off.

3.4.3 Removing forks(SR1218D)

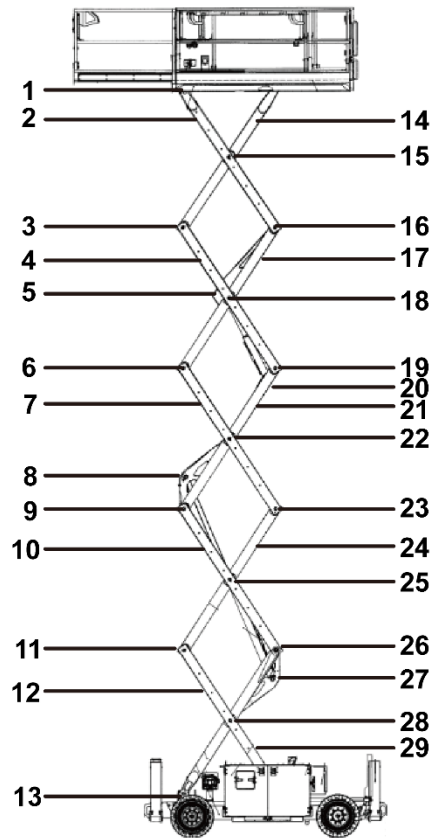

Fig. 3.12 SR1218D Fork assembly

- | | |
|--------------------------------------|--|
| 1. 6# pin | 16. 5# pin (non-steering end) |
| 2. Fifth outer arm | 17. Fourth inner arm |
| 3. 5# pin (steering end) | 18. 4# center pin |
| 4. Fourth outer arm | 19. 4# pin (non-steering end) |
| 5. Upper lift cylinder rod end shaft | 20. Upper lift cylinder tube end shaft |
| 6. 4# pin (steering end) | 21. Third inner arm |
| 7. Third outer arm | 22. 3# center pin |
| 8. Lower lift cylinder rod end shaft | 23. 3# pin (non-steering end) |
| 9. 3# pin (steering end) | 24. Second inner arm |
| 10. Second outer arm | 25. 2# center pin |
| 11. 2# pin (steering end) | 26. 2# pin (non-steering end) |
| 12. First inner arm | 27. Lower lift cylinder tube end shaft |
| 13. 1# pin (steering end) | 28. 1# center pin |
| 14. Fifth inner arm | 29. First outer arm |
| 15. 5# center pin | |

**WARNING: Risk of personal****injury**

This procedure requires specific maintenance skills, lifting equipment and a suitable workshop. Carrying out this process without these skills and tools may result in death or serious injury, as well as serious component damage. Therefore, it is strongly recommended that this service is performed by dealers.

**Caution:**

The O-ring (if any) of the removed fitting and hose assembly must be replaced. During installation, all connections must be tightened to specified torque. Please refer to the specification for selection of tightening torque of the lifting platform.

1. Remove the platform.
2. Support and attach the access ladder to an appropriate lifting equipment, remove the fasteners from the access ladder, and then remove the access ladder from the machine.
3. Remove the cables and harnesses from the wiring ring of the fifth outer arm and the wiring board of the fifth inner arm, and set them aside.
4. Remove the wiring boards of the fourth to fifth arms from the machine.
5. Attach the sling of the traveling crane to the fifth outer arm.
6. Remove the fasteners that fix the 5# center pin.
7. Knock out the 5# center pin using a soft metal hammer and remove it from the machine.
8. Remove the fasteners that fix the 5# pin at the non-steering end.

9. Remove the 5# pin from the non-steering end of the machine using a soft metal hammer. Remove the fifth outer arm from the machine.

**WARNING: Risk of personal injury.**

If not properly supported during removal, the fifth outer arm may be out of balance and fall off.

**WARNING: Risk of crushing**

If not properly supported during removal of cylinder rod end pin, the cylinder may fall off.

**WARNING: Risk of personal injury.**

If not properly supported during removal, the fourth outer arm may be out of balance and fall off.

10. Attach the sling of the traveling crane to the fifth inner arm.
11. Remove the fasteners that fix the 5# pin (4) at the steering end of the machine.
12. Remove the 5# pin from the steering end of the machine using a soft metal hammer. Remove the fifth inner arm from the machine.
13. Mark, disconnect and plug the hydraulic hose of upper lift cylinder. And cover the fittings on the cylinder.
14. Mark and disconnect the harness of the cylinder valve block.
15. Attach the sling of the traveling crane to upper lift cylinder rod end.
16. Remove the fasteners that fix the upper lift cylinder rod end pin.
17. Remove the upper lift cylinder rod end pin from the machine using a soft metal hammer.
18. Attach the sling of the traveling crane to the lug of the upper lift cylinder rod end.

19. Lift the lift cylinder to a vertical position.
20. Remove the fasteners that fix the lift cylinder tube end pin. Remove the upper lift cylinder from the machine.

 **WARNING: Risk of crushing**

If not properly supported during removal of cylinder tube end pin, the cylinder may fall off.

 **CAUTION: Risk of part damage**

When removing the cylinder from the machine, be careful not to damage the valve or joint on the cylinder.

21. Remove the fasteners that fix the 4# center pin on the fuel tank side.
22. Remove the cables and harnesses from the wiring board of the fourth inner arm, and set them aside.
23. Remove the fasteners that fix the wiring board of the fourth inner arm, and remove the wiring boards of third to fourth arms.
24. Remove the 4# center pin on the fuel tank side using a soft metal hammer.
25. Remove the fasteners that fix the 4# pin at the non-steering end.
26. Remove the 4# pin from the non-steering end of the machine using a soft metal hammer. Remove the fourth outer arm on the fuel tank side from the machine.
27. Attach the sling of the traveling crane to the fourth outer arm on the engine case side.
28. Remove the fasteners that fix the 4# center pin on the engine case side. Pass a rod through the 4# center pin on the engine case side and twist it to remove the pin. Remove the fourth outer arm from the machine.
29. Remove the 4# center pin shaft on the engine case side using a soft metal hammer.

30. Remove the fourth outer arm from the machine.

 **WARNING: Risk of crushing.**

If not properly supported during removal, the fourth outer arm may be out of balance and fall off.

31. Attach the sling of the traveling crane to the fourth inner arm.
32. Remove the fasteners that fix the 4# pin at the steering end of the machine.
33. Remove the 4# pin from the steering end of the machine using a soft metal hammer. Remove the fourth inner arm from the machine.
34. Attach the sling of the traveling crane to the third outer arms on the fuel tank side and engine case side of the machine.
35. Remove the fasteners that fix the 3# center pin.
36. Remove the 3# center pin using a soft metal hammer.
37. Remove the fasteners that fix the 3# pin at the non-steering end.
38. Remove the 3# pin from the non-steering end of the machine using a soft metal hammer. Remove the third outer arms on both sides of the machine.
39. Remove the cables and harnesses and hydraulic hoses from the wiring board and the wiring ring of the third inner arm.
40. Remove the fasteners that fix the wiring boards of the second to third arms, and remove the wiring boards.

 **WARNING: Risk of personal injury.**

If not properly supported during removal, the third outer arm may be out of balance and fall off.

41. Attach the sling of the traveling crane to lower

lift cylinder rod end.

42. Remove the fasteners that fix the lower lift cylinder rod end pin.
43. Remove the lower lift cylinder rod end pin from the machine using a soft metal hammer.
44. Place a 10 x 10 x 25 cm cushion block on the first inner arm cylinder plate.



WARNING: Risk of personal injury.

When lowering the cylinder, do not touch the moving parts with hands.

45. Lower the cylinder to the cushion block.
46. Attach the sling of the traveling crane to the third inner arm.
47. Remove the fasteners that fix the 3# pin at the steering end of the machine.
48. Remove the 3# pin from the steering end of the machine using a soft metal hammer. Remove the third inner arm from the machine.
49. Attach the sling of the traveling crane to the second outer arms on the fuel tank side and engine case side of the machine.
50. Remove the fasteners that fix the 2# center pins on both sides of the machine.
51. Remove the 2# center pin on both sides of the machine using a soft metal hammer.
52. Remove the fasteners that fix the 2# pin at the non-steering end.
53. Remove the 2# pin from the non-steering end of the machine using a soft metal hammer. Remove the second outer arms on both sides of the machine.



WARNING: Risk of crushing

If not properly supported during removal, the second outer arm may be out of balance and fall off.

54. Remove the cables and harnesses and hoses from the wiring boards of the second to third

arms, and set them aside.

55. Remove the fasteners that fix the wiring boards of the second to third arms, and remove the wiring boards.
56. Attach the sling of the traveling crane to the second inner arm. Lift the arm to a vertical position.
57. Remove the fasteners that fix the 2# pin at the steering end of the machine.
58. Remove the 2# pin from the steering end of the machine using a soft metal hammer. Remove the second inner arm from the machine.
59. Remove the cables and harnesses and hydraulic hoses from the wiring ring of the first inner arm.
60. Attach the sling of the traveling crane to the first inner arm.
61. Lift the first inner arm for 60cm.
62. Place a 10cm×10cm×1.2mcushion block under the 1# center pin (13) across both sides of the chassis.
63. Lower the fork onto the cushion block placed on the chassis.



WARNING: Risk of personal injury.

When lowering the cylinder, do not touch the moving parts with hands.

64. Attach the sling of the traveling crane to the lower lift cylinder.
65. Mark, disconnect and plug the hydraulic hose of lower lift cylinder. and cover the fittings on the cylinder.



WARNING: Risk of personal injury.

Splashed hydraulic oil will penetrate and burn the skin. Therefore, please loosen hydraulic connectors very slowly to reduce the oil pressure gradually.

Prevent the oil from spraying or ejection.

66. Mark and disconnect the harnesses and hoses of the cylinder valve.
67. Mark and disconnect the harnesses of the platform overload sensor.
68. Lift the lift cylinder to a vertical position.
69. Remove the fasteners that fix the lift cylinder tube end pin. Remove the pin using a soft metal hammer. Remove the lower lift cylinder from the machine.
70. Attach the sling of the traveling crane to the first inner arm.
71. Lift the arm slightly and remove the cushion block.
72. Attach the sling of the traveling crane to the first outer arm. Do not apply any lifting force.
73. Remove the outer snap ring and fasteners that fix the 1# center pin.
74. Remove the 1# center pin using a soft metal hammer.
75. Slide the first outer arm to the non-steering end and remove it from the machine.
76. Attach the sling of the traveling crane to the first inner arm. Do not lift it.
77. Remove the fasteners that fix the travel switch cover on the first inner arm, and remove cover from the machine.
78. Remove the fasteners of the lower limit switch mounting plate, disconnect the limit switch connecting wire, and remove the lower limit switch and its mounting plate from the machine.
79. Remove the fasteners that fix the pin for connecting the first inner arm to the end of the chassis. Remove the pin.
80. Remove the first inner arm from the machine.

 **WARNING: Risk of personal injury.**
If not properly supported during

removal, the first inner and outer arms may be out of balance and fall off.

 **WARNING: Risk of personal injury.**

Be careful not to damage the limit switch when removing the first inner and outer arms from the machine.

3.4.4 Assembly the Fork

1. Assembling the first fork

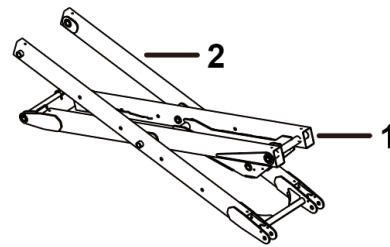

Fig. 3.13 first fork

1. First inner arm assembly 2. First outer arm weldment

- a. Hoist the first outer arm and the first inner arm to the fork subassembling tooling;

Note:

- Place the first outer arm first, and keep it centered and its rear end placed firmly as shown;
- Pay attention to the direction of the upper, lower and front and rear ends of the inner and outer arms.
- Prevent the part from being lifted above any personnel, and during the lifting, keep the part in balance. The operator shall stay at a certain distance from the part, and hold the part at its outer side or other places where crushing is impossible;
- Follow the requirements herein for hoisting of forks of subsequent layers.

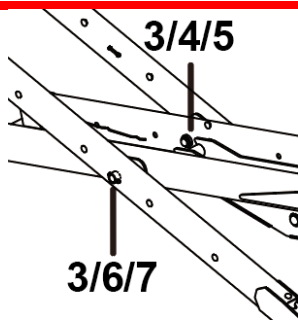

Fig. 3.14 Installation of first layer fork

3. Shaft 4. Washer 5. Retaining ring 6. Nut 7. Bolt

b. Connect the middle positions of the first inner arm and first outer arm with shaft (3) as shown in the Fig.;

Note: For each layer, direct the large chamfered end of the shaft inward, and insert both ends of shaft from outside to inside.

c. Install parts 6/7 to the outer end of the fork (3) and parts 4/5 to the inner end of the fork (3) as shown; confirm that the retaining ring is clamped in place;

Note: During the installation of part 4, as no wiring board is installed at this position, it is required to install 2 washers (4), and for forks of other layers where a wiring board is installed, it is only required to install 1 washer and secure it with a retaining ring.

Tightening torque of part 7: $52 \pm 5 \text{N.m}$;

Tools: copper rod, circlip pliers, ratchet torque wrench QSP100, socket wrench 1/2-16mm, electric impact wrench 51073C, open-end wrench 16-18

2. Assembling the lower lift cylinder

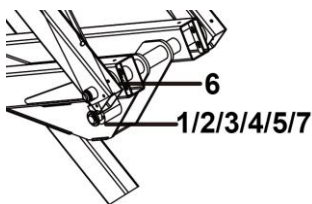

Fig. 3.15 Assembling the lower lift cylinder

1. Shaft 2. Bolt 3. Thick washer 4. Nut 5. Safety pin 6. Washer 7. Washer

a. Use the traveling crane to hoist the cylinder with the mounting holes at the bottom of cylinder aligned with the holes on the first inner arm as shown in Fig.3.15, fix the cylinder with part 1, and separate the bottom of the cylinder from the inner side of the first inner arm with part 6, as shown in Fig. 3.15.

b. After fixing the lower part of the cylinder with a shaft, fix the shaft with parts 2/3/4/5/7 as shown in Fig. 3.15 and tighten it to the specified torque;

Tightening torque of part 2: $90 \pm 9 \text{N.m}$;

Tools: copper rod, ratchet torque wrench QSP200, socket wrench 1/2 18, open-end wrench 16-18.

3. Assembling the wiring board of first fork

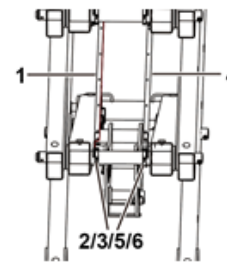

Fig. 3.16 Assembling the wiring board of first fork

1. Left wiring board assembly 2. Retaining ring 3. Retaining ring 4. Right wiring board assembly 5. Screw 6. Screw

a. Fix the part 1 to the first inner arm round steel and the connecting shaft between the second inner arm and the second outer arm, and secure at the connecting shaft with retaining ring.

b. Install parts 2 and 3 to the left and right sides of the round steel with parts 5 and 6, and pay attention that the fixing screws are only required to be manually screwed into the mounting holes.

Tools: Phillips screwdriver, hexagon socket set

4. Assembling the first and second forks

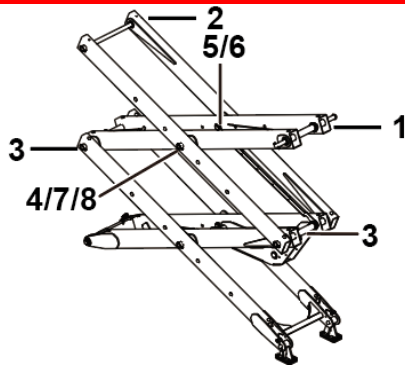

Fig. 3.17 Assembling the first and second forks

1. Second inner arm assembly 2. Second outer arm 3. Shaft 4. Shaft 5. Washer 6. Retaining ring 7. Nut

- Assemble the side of part 1 close to the upper end of the cylinder to the first outer arm with part 3;
- Assemble part 1 to part 2 with part 4;
- Assemble the end of part 2 close to the lower part of the cylinder to the first inner arm with part 3;
- When connecting the part 1 to the part 2 with part 4, fix the outer side of the fork (the short side) with parts 7/8, and the inner side of the fork with parts 5/6;
- When the part 3 is used for assembling, fix one side with parts 7/8 and the other side with parts 5/6;

Tightening torque of part 8: $52 \pm 5 \text{N.m}$

Tools: torque wrench QSP100, circlip pliers, socket wrench 1/2-16mm, electric impact wrench 51073C

5. Routing the lower cylinder oil pipes

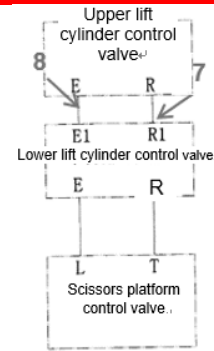
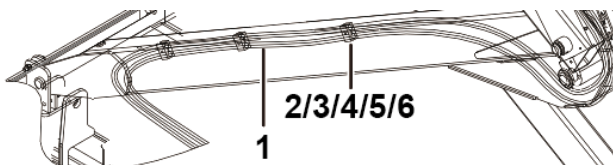

Fig. 3.18 Routing the lower cylinder oil pipes

1. Hose 2. Pressure plate 3. Pipe clamp 4. Bolt 5. Nut 6. Washer 7. Hose 8. Hose

- Assemble the part 1 to port E and port R at the lower end of the lower cylinder control valve, and tighten it to the specified torque;
- Lay the oil pipe along the cylinder and curve it at the lower end of the cylinder as shown in the Fig., then lay it along the fork on the left side of cylinder, fix it on the left side of fork with parts 2/3/4/5/6 (as shown), and tighten the part 4.
- Install part 7 and part 8 to port R1 and port E1 of the lower cylinder valve block respectively, and mark E1 and R1 on the other end of the oil pipe respectively for the convenience of subsequent connection.
- Ensure that the ties are spaced by at least 300mm, and the section of oil pipe between ties does not sag.
- Wrap the curve of pipe with PVC tape and the ends of pipe with 2-3 turns of black insulating tape, and keep the outer end of the curve of pipe about 50mm away from the edge of the fork rectangular tube;

Tightening torque of part 1: $32 \pm 3 \text{N.m}$

Tightening torque of part 2: $42 \pm 4 \text{N.m}$

Tools: needle-nosed pliers, torque wrench SP67N*24, torque wrench SP67N*22, tie (on demand), PVC tape (on demand), black insulating tape (on demand)

6. Assembling the safety support

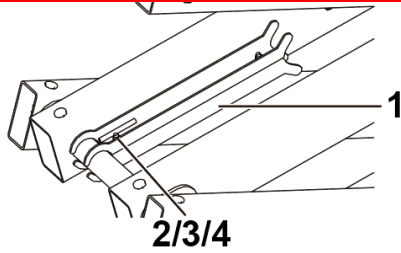

Fig. 3.19 Assembling the safety support

1. Bend plate assembly 2. Bolt 3. Washer 4. Nut
 - a. Assemble part 1 to the second inner arm with parts 2/3/4 without tightening, and when it fits closely with the left support (indicated by the red circle in the Fig.), tighten it to the specified torque;
 - b. After assembling, test whether the safety support can be placed on the left support, as shown in Fig. 3.19;
 - c. When assembling the protective arm, direct the nut outward.

Tightening torque of part 2: $52 \pm 5 \text{N.m}$;

Tools: open-end wrench 16-18, ratchet torque wrench QSP100, socket wrench 1/2-16mm

7. Assembling the third fork and lower cylinder

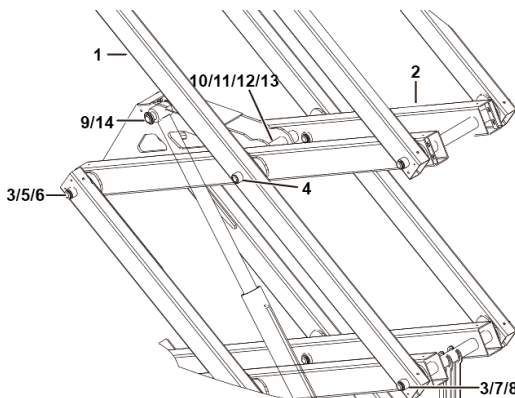

Fig. 3.20 Assembling the third fork and lower cylinder

1. Third outer arm weldment 2. Third inner arm assembly 3. Shaft 4. Shaft 5. Bolt 6. Nut 7. Retaining ring 8. Washer 9. Shaft 10. Washer 11. Bolt 12. Thick washer 13. Nut 14. Bolt
 - a. Hoist the third outer arm and the third inner arm above the second inner arm and second outer arm;
 - b. Connect the part 2 to the second outer arm with shaft (3) and the part 1 to the second

inner arm;

- c. assemble part 1 to part 2 with part 4, fix the outer side of the fork with parts 5/6, and clamp the inner side of the fork with parts 7/8;
- d. fix the shaft (3) with parts 4/5, and clamp the other end with parts 7/8;

Note : Before fixing with parts 4/5, it is required to fix the other side of the shaft with bolts to ensure an overall consistence;

- e. Assemble the upper end of the lower cylinder to part 2 with part 9, and separate the fixing hole at the upper end of the cylinder from the inner side of fork with part 10;
- f. After the part 9 is in place, fix the shaft with parts 11/12/13/14 and tighten it to the specified torque;

Note: Do not forget to install the washer between the fixing hole at the upper end of the cylinder and the inner side of the fork; install a thick washer between the safety pin and the fork.

Tools: copper rod, ratchet torque wrench QSP200, socket wrench 1/2 18, open-end wrench 16-18

Note: The Articles g, h, I and j below are for assembling of SR1018D third fork.

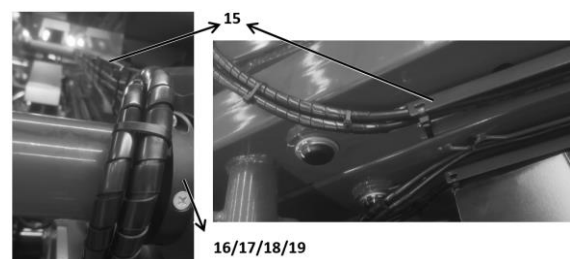

Fig. 3.21 Assembling the third fork pipeline

15. Right wiring board assembly 16. Screw 17. Screw 18. Retaining ring 19. Retaining ring
 - g. Fix the part 15 to the connecting shaft between the second inner arm round steel

and the third outer arm, and secure at the connecting shaft with retaining ring.

- h. Install parts 16 and 17 to the right side of the round steel with parts 18 and 19, and pay attention that the fixing screws are only required to be manually screwed into the mounting holes.

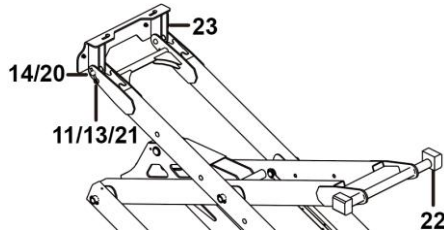

Fig. 3.22 Assembling the third fork

- 20. Shaft 21. Washer 22. Slider 23 Upper mount assembly

- i. Assemble part 23 to the double lug of fifth outer arm (part 1) with part 20, fix part 20 with parts 11/13/14/21, and tighten it to the specified torque;
 - j. Assemble the part 22 on both ends of the round steel of the fifth outer arm weldment (part 1).
8. Three-layer cable board assembly

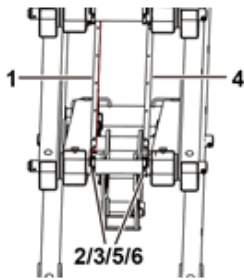

Fig. 3.23 Three-layer cable board assembly

- 1. Left wiring board assembly 2. Retaining ring 3. Retaining ring 4. Right wiring board assembly 5. Screw 6. Screw

- a. Fix the part 1 to the second inner arm round steel and the connecting shaft between the third inner arm and the third outer arm, and secure at the connecting shaft with retaining ring.
- b. Install parts 2 and 3 to the left and right sides of the round steel with parts 5 and 6, and pay

attention that the fixing screws are only required to be manually screwed into the mounting holes.

Note: For the location where the wiring board is installed, only one pin washer is required, and for the location where the wiring board is not installed, two washers are required and need to be secured by retaining rings.

- 9. Assembling the fourth fork(SR1018D)

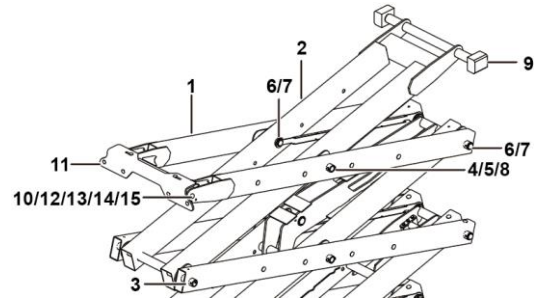

Fig. 3.24 Assembling the fourth fork (SR1018D)

- 1. Fifth outer arm weldment 2. Fifth inner arm assembly 3. Shaft 4. Nut 5. Bolt 6. Retaining ring 7. Washer 8. Shaft 9. Slider 10. Shaft 11. Upper mount assembly 12. Safety pin 13. Bolt 14. Nut 15. Washer

- a. Connect the part 1 to the fourth inner arm with part 3, fix the part 3 on the fork with parts 4/5, and clamp the part 3 on the other side of the fork with parts 6/7;
- b. Connect the part 2 to the fourth outer arm with part 3, fix the part 3 on the fork with parts 4/5, and clamp the part 3 on the other side of the fork with parts 6/7;
- c. Fix part 1 and part 2 together with part 8, fix the end of part 8 on the outer side of the fork with parts 4/5, and clamp the inner side of the fork with parts 6/7;
- d. Assemble the part 9 at both ends where the fourth inner arm is fixed;
- e. Assemble part 11 to the double lug of fourth outer arm with part 10, fix part 10 with parts 12/13/14/15, and tighten it to the specified torque;

10. Routing and tying the harness(SR1018D)

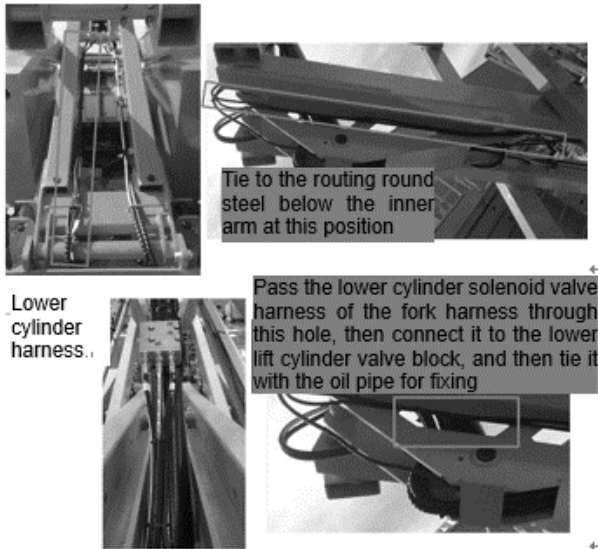

Fig. 3.25 Routing and tying the harness (SR1018D)

- a. Keep the harness and oil pipe at the fork in the same direction, with the oil pipe on the left side of fork and the harness on the right side of fork. See the Fig. for the specific routing direction. After the harness is routed to the fourth fork and through the wiring board, throw it directly out from the upper part of the intermediate shaft of the fork, and keep the reserved harness about 50mm away from the fork surface.
- b. Fix the harness into all the fixing holes on the wiring board with ties, keep the ties on the routing round steel spaced by 300mm, and ensure that the harness does not sag at any position.
- c. Secure the two oil pipes of the lower lift cylinder with ties every 300mm from the position 100mm away from the oil pipe joint to the position where the oil pipe is bent.
- d. At each curves, keep the outermost side of the curve about 50mm away from the round steel and the pin, and use PVC tape to protect the harness at each curving position, in which case wrapping of single harness is not required.

Note: If the platform power harness

needs to be assembled, keep its direction consistent with the PCU harness.

11. Assembling the fourth fork and upper cylinder(SR1218D)

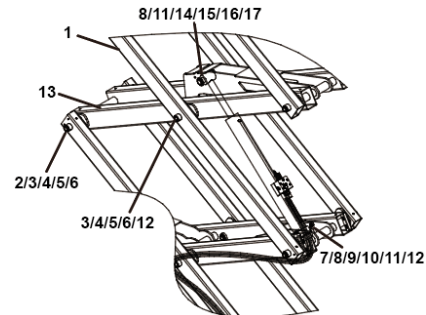

Fig. 3.26 Assembling the fourth fork and upper cylinder (SR1218D)

1. Third outer arm weldment 2. Shaft 3. Bolt 4. Nut 5. Retaining ring 6. Washer 7. Pin pressure plate 8. Washer 9. Bolt 10. Shaft 11. Bolt 12. Washer 13. Fourth inner arm assembly 14. Shaft 15. Thick washer 16. Bolt 17. Nut
- a. Connect part 1 to the third inner arm with part 2 first, then fix the part 2 with parts 3/4/5/6, and tighten it to the specified torque. The position of part 5 and part 6 are the same as those of the forks of the first three layers;
- b. Insert the through hole at the bottom of upper cylinder into the part 10, sleeve the part 8 on the part 10 at the left and right ends of the cylinder, then assemble it to the third inner arm, clamp it with part 7, fix it with parts 9/11/12, and tighten it to the specified torque;
- c. Assemble part 13 to the third outer arm with part 2, fix the part 2 on the fork with parts 3/4/5/6, and tighten it to the specified torque;
- d. Assemble part 1 to part 13 with part 14, fix part 12 with parts 3/4/5/6, and tighten it to the specified torque;
- e. Adjust the position of the upper lift cylinder, assemble the cylinder on the fourth inner arm with parts 8/17, fix part 17 with parts 13/14/15/16, and tighten it to the specified

torque;

Tightening torque of part 3: 52±5N.m;

Tightening torque of parts 9/11: 52±5N.m;

Tightening torque of part 16: 90±9N.m;

Tools: copper rod, ratchet torque wrench QSP100, socket wrench 1/2 18, open-end wrench 16-18

12. Three-layer cable board assembly(SR1218D)



Fig. 3.27 Three-layer cable board assembly (SR1218D)

1. Retaining ring 2. Retaining ring 3. Right wiring board assembly 5. Screw

- a. Fix the part 3 to the third inner arm round steel and the connecting shaft between the fourth inner arm and the fourth outer arm, and secure at the connecting shaft with retaining ring.
- b. Install parts 1 and 2 to the right side of the round steel with parts 4 and 5, and pay attention that the fixing screws are only required to be manually screwed into the mounting holes.

CAUTION: For the location where the wiring board is installed, only one pin washer is required, and for the location where the wiring board is not installed, two washers are required and need to be secured by retaining rings.

13. Routing and connecting oil pipes(SR1218D)

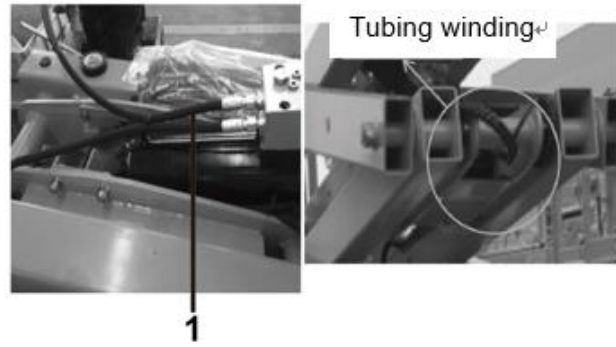

Fig. 3.28 Routing and connecting oil pipes(SR1218D)

1. Hose

- a. Connect the part 1 to the designated position of the valve block according to the mark on the oil pipe, and tighten it to the specified torque;
- b. Lay the oil pipe along the bottom of the cross beam of fourth inner arm and connect it to the inside of inner arm as shown;
- c. Pay attention to the routing direction and winding method of oil pipe, and avoid the pipe from being squeezed.

Tightening torque of part 1: 32±3N.m;

Tools: open-end torque wrench 22

14. Assembling the fifth fork(SR1218D)

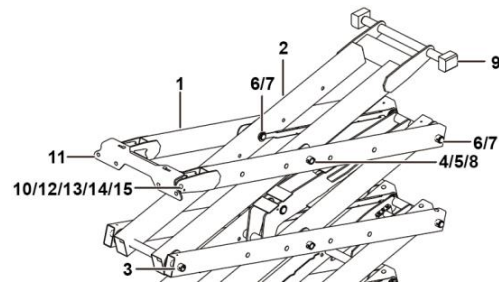

Fig. 3.29 Assembling the fifth fork (SR1218D)

1. Fifth outer arm weldment 2. Fifth inner arm assembly 3. Shaft 4. Nut 5. Bolt 6. Retaining ring 7. Washer 8. Shaft 9. Slider 10. Shaft 11. Upper mount assembly 12. Safety pin 13. Bolt 14. Nut 15. Washer

- a. Connect the part 1 to the fourth inner arm with part 3, fix the part 3 on the fork with parts 4/5, and clamp the part 3 on the other side of the fork with parts 6/7;
- b. Connect the part 2 to the fourth outer arm with part 3, fix the part 3 on the fork with parts 4/5,

and clamp the part 3 on the other side of the fork with parts 6/7;

- c. Fix part 1 and part 2 together with part 8, fix the end of part 8 on the outer side of the fork with parts 4/5, and clamp the inner side of the fork with parts 6/7;
- d. Assemble the part 9 at both ends where the fifth inner arm is fixed;
- e. Assemble part 11 to the double ear of fifth outer arm with part 10, fix part 10 with parts 12/13/14/15, and tighten it to the specified torque;

Tightening torque of part 5: 52±5N.m;

Tightening torque of part 13: 90±9N.m;

ools: copper rod, ratchet torque wrench QSP200, socket wrench 1/2 18, open-end wrench 16-18

15. Assembling the wiring board of fifth fork (SR1218D)

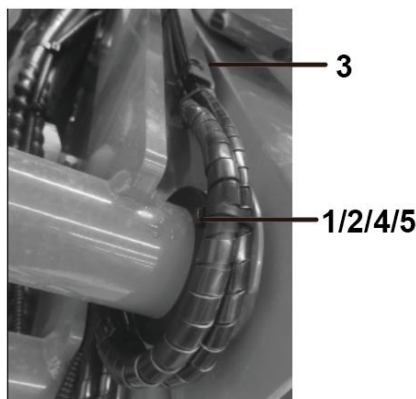

Fig. 3.30 Assembling the wiring board of fifth fork (SR1218D)

1. Retaining ring 2. Retaining ring 3. Right wiring board assembly 4. Screw 5. Screw

- a. Fix the part 3 to the connecting shaft between the fourth inner arm round steel and the fifth inner arm/fifth outer arm, and secure at the connecting shaft with retaining ring. The part 3 is to be fixed on the right side of the fork.
- b. Install parts 1 and 2 to the right side of the round steel with parts 4 and 5, and pay attention that the fixing screws are only

required to be manually screwed into the mounting holes.

Note: For the location where the wiring board is installed, only one pin washer is required, and for the location where the wiring board is not installed, two washers are required and need to be secured by retaining rings.

Tools: Phillips screwdriver, hexagon socket set

16. Routing and tying the harness(SR1218D)

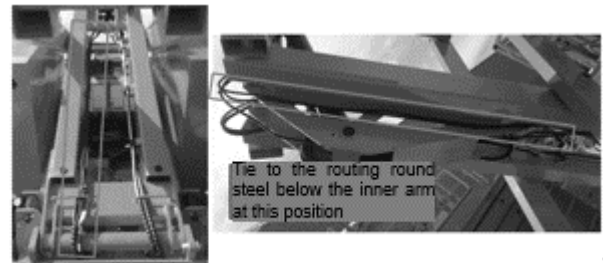

Pass the lower cylinder solenoid valve harness of the fork harness through this hole, then connect it to the lower lift cylinder valve block, and then tie it with the oil pipe for fixing



Fig. 3.31 Routing and tying the harness (SR1218D)

- a. Keep the harness and oil pipe at the fork in the same direction, with the oil pipe on the left side of fork and the harness on the right side of fork. See the Fig. for the specific routing direction. After the harness is routed to the fifth fork and through the wiring board, throw it directly out from the upper part of the

intermediate shaft of the fork, and keep the reserved harness about 50mm away from the fork surface.

- b. Fix the harness into all the fixing holes on the wiring board with ties, keep the ties on the routing round steel spaced by 300mm, and ensure that the harness does not sag at any position.
- c. Secure the two oil pipes of the lower lift cylinder with ties every 300mm from the position 100mm away from the oil pipe joint to the position where the oil pipe is bent.
- d. Tie the pressure sensor harness of the valve block on the lift cylinder to the oil pipe of the cylinder, and ensure that pressure sensor connector is not stressed, stretched or kinked.
- e. At each curves, keep the outermost side of the curve about 50mm away from the round steel and the pin, and use PVC tape to protect the oil pipe, in which case wrapping of single harness is not required.

Note: If the platform power harness needs to be assembled, keep its direction consistent with the PCU harness.

17. Assembling and replacing the slider

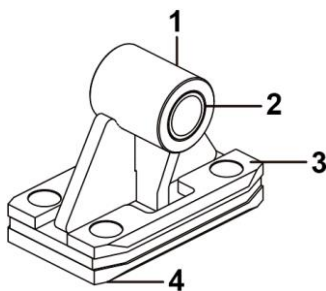

Fig. 3.32 Assembling and replacing the slider

1. Support 2.Sleeve 3. Slider 4. Slider

- a. Install the shaft sleeve (2) into the shaft hole of the support (1), as shown in Fig. 3.32;
- b. Fasten parts 3 and 4 shown in Fig. 3.32 to part 1;

Note:Keep the part 3 on the upper part and the part 4 on the lower part.

- c. Place the slider assembly on the material rack

instead of on the ground;

18. Lifting the fork

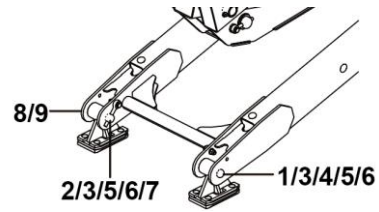

Fig. 3.33 Lifting the fork

1. Fixing plate pin 2. Shaft 3. Safety pin 4. Bolt 5. Nut 6. Washer 7. Bolt 8. Washer 9. Retaining ring

- a. Lift the assembled fork to the position above the chassis, adjust the position of the fork, and install the part 1 on the front side of the machine, and after the installation is completed, lower the traveling crane, align the rear side of the fork with the shaft hole of the slider, and insert the part 2.
- b. Fix the part 1 with parts 3, 4, 5, 6, 8 and 9 after installation, and fix the part 2 with parts 3, 5, 6 and 7 after installation.

Tightening torque of parts 4/7: 90±9N.m;

Tools: copper rod, ratchet torque wrench QSP200, socket wrench 1/2 18, open-end wrench 16-18, tie (on demand), PVC tape (on demand)

3.4.5 Replacing the fork slider at platform

1. Attach the sling of the lifting equipment to the lower part of the platform at the steering end of the machine, and pay attention not to attaching the sling to the railing of the platform.
2. Attach the sling of the lifting equipment to the lower part of the platform at the non-steering end of the machine, and pay attention not to attaching the sling to the railing of the platform.
3. Lift the platform slightly with lifting equipment until the stress on the slider is just relieved.
4. Slide out the fork assembly from the platform until two fork sliders are accessible.

! WARNING: Risk of crushing.

If not properly supported with lifting equipment during removal of platform slider pivot, the platform may fall.

5. Remove the two old sliders and replace them with new ones.
6. Install the slider assembly into the platform slideway.

3.4.6 Replacing the fork slider at chassis

1. Support and attach the access ladder to an appropriate lifting equipment, remove the fasteners from the access ladder, and then remove the access ladder from the machine;
2. Use sling or other suitable means to fix the two ends of the fork to the two ends of the machine.
3. Attach the sling of the lifting equipment to the end of the scissor arm for removal of slider.
4. Lift the scissor arm slightly with lifting equipment until the stress on the slider is just relieved.
5. Remove the fastener from the slider pivot and set it aside.

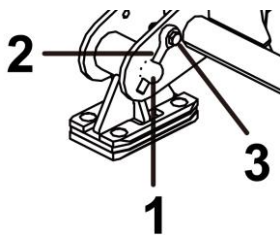

Fig. 3.34 Installation position of fork slider at chassis

1. Shaft 2. Safety pin 3. Bolt

6. Remove the slider pivot and set it aside. Slide the slider out of the slideway, and remove it from the machine.
7. Remove the fasteners that fix the wear pad from the slider assembly, and remove the wear pad.
8. Install a new wear pad on the slider.
9. Install the slider assembly into the chassis

slideway.

10. Align the holes on the slider assembly with the holes on the scissor arm.
11. Install the slider pivot and its fasteners.
12. Lower the platform to the stowed position.

3.5 Engine assembly

3.5.1 Installing engine mounts

1. Install part 1 to the engine left front mounting holes with four parts 4 and 5, and tighten it to the specified torque as shown;
2. Install part 2 to the engine right front mounting holes with four parts 4 and 5, and tighten it to the specified torque as shown;
3. Install part 3 to the mounting holes on the left and right sides of the rear of the engine with two parts 4 and 5, and tighten it to the specified torque as shown;

Apply AT272 thread locker to part 3 before installation; parts 1 and 2 are bent towards the outside of the engine, and part 3 is bent towards the inside of the engine.

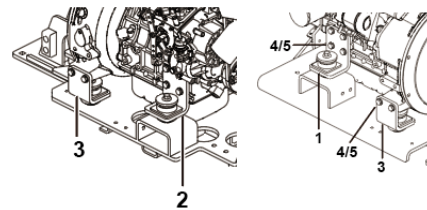

Fig. 3.35 engine mounts

1. Engine left front mount 2. Engine right front mount 3. Engine left rear mount 4. Bolt 5. Washer

**Tightening torque of part 4: 52±5N.m;
Tools: electric impact wrench (SATA 51073),
socket wrench 1/2-16mm,
ratchet torque wrench QSP100**

3.5.2 The pump cover and coupling

1. Removing the pump cover and coupling
 - a. Release the latch on the engine tray, slide the engine tray completely out, and fix the engine tray after sliding it out to prevent it from moving.

- b. Connect the sling of the crane to the walking variable pump for support. Do not lift it.
- c. Remove the fasteners that connect the walking variable pump to the engine assembly.
- d. Carefully pull the pump assembly away from the engine and make sure it does not move.



CAUTION: Risk of part damage.

If squeezed or twisted, the hose may be damaged.

- e. Remove the fasteners that fix the pump cover, and remove the pump cover from the engine.
 - f. Remove the fasteners that fix the flywheel coupling, and remove the coupling from the flywheel.
2. Installing the pump cover and coupling
- a. Install part 1 to the engine with part 3, and tighten it to the specified torque as shown;
 - b. Install parts 1, 4 and 5 to the engine with parts 6, 7 and 8, and parts 4 and 5 and part 1 are shared;

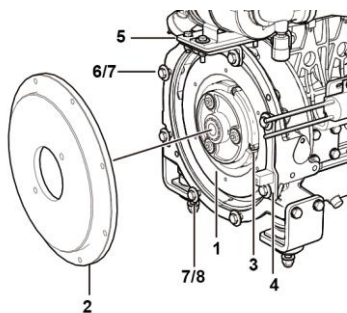

Fig. 3.36 The pump cover and coupling

1. Plate 2. Coupling 3. Screw 4. Water separator bracket weldment 5. Support plate weldment 6. Bolt 7. Washer 8. Bolt

Tightening torque of part 3: 49±5N.m;

Tightening torque of parts 6/8: 52±5N.m.

Tools: electric impact wrench (SATA 51082),

socket wrench 1/2-16mm, ratchet torque wrench QSP100, hexagon head socket wrench 1/2-8mm

3.5.3 Installing the solenoid valve

1. Install part 1 to part 2 with parts 5, 6 and 7 as shown, and tighten it to the specified torque;
2. Screw the part 8 into the solenoid valve screw, and then screw the screw seat end of the part 9 to the solenoid valve screw; tighten the part 8 after adjusting the speed;
3. Install part 2 to the engine with four parts 3 and 4, and tighten it to the specified torque as shown;

Apply AT272 thread locker on the part 3 before installing it.

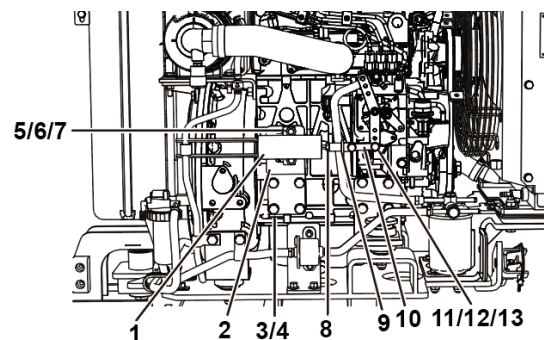

Fig. 3.37 Solenoid valve

1. Solenoid valve 2. Solenoid valve bracket weldment 3. Bolt 4. Washer 5. Bolt 6. Washer 7. Nut 8. Nut 9. Fixing seat 10. Pull rod 11. Bolt 12. Washer 13. Nut

Tightening torque of part 3: 52±5N.m;

Tightening torque of part 5: 12±1N.m

Tools: electric impact wrench (SATA 51073), socket wrench 1/2-16mm,

ratchet torque wrench QSP100, open-end wrench 11-13, open-end wrench 10-12, socket wrench 1/2-10mm

4. Use one part 11, two parts 12, and one part 13 to fix the parts 9 and 10, and then tighten them;
5. Use one part 11, two parts 12, and one part 13 to fix the part 9 to the rocker arm of the

engine, and then tighten them;

Tightening torque of part 3: 52±5N.m;

3.5.4 The gear pump

1. Removing the gear pump

 **CAUTION:**

Before refitting, the O-ring of the removed fitting and/or hose assembly must be replaced and then tightened to the specified torque. Please refer to hydraulic hose and fitting torque specifications.

 **CAUTION:**

When installing the gear pump again, check the position of the O-ring before installation to avoid squeezing the O-ring.

(1) Find the valve at the hydraulic tank and close the valve.

 **CAUTION: Risk of part damage.**

The engine shall not be started when the valve of the hydraulic tank is closed, otherwise parts may be damaged. If the valve is closed, remove the key from the key switch and put a label on the machine to inform related personnel.

(2) Push out the engine tray and fix the tray to prevent it from sliding.

(3) Mark, disconnect and plug the hydraulic hose of the gear pump.

 **WARNING: Risk of personal injury.**

Splashed hydraulic oil may penetrate and burn the skin. Therefore, please loosen hydraulic connectors very slowly to reduce the oil pressure gradually. Do not spray or splash oil.

(4) Remove the gear pump mounting fasteners and carefully remove the pump.

2. Installing the gear pump

(1) Install part 1 to the engine coupling, with the gear pump spline shaft well matched with the coupling; use parts 2 and 3 to fix it; the direction of the oil pumping is shown by the arrow in the Fig. above; the spline of the gear pump must not be missing.

(2) Install part 4 to the oil inlet S of the gear pump, tighten it to the specified torque, and then install part 6 to part 4, and tighten it to the specified torque after the connecting pipes are straightened out, and the part 6 is basically kept horizontal;

(3) Install part 5 to the oil outlet P of the gear pump, and tighten it to the specified torque.

Part 2 Apply AT262 thread locker before installation.

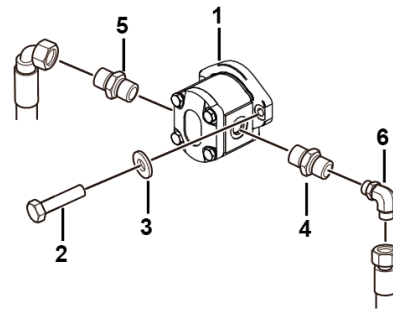

Fig. 3.38 The gear pump

1. Gear pump 2. Bolt 3. Washer 4. Joint 5.

Joint 6. Joint

Tightening torque of part 2: 120±8N.m;

Tightening torque of part 4: 162±16N.m;

Tightening torque of part 5: 102±10N.m;

Tightening torque of part 6: 135±14N.m;

Tools: electric impact wrench 51082, socket wrench 1/2-18mm, torque wrench SP200N*41, torque wrench QSP200, extension socket wrench 3/4-41mm, socket wrench 1/2-27mm

3.5.5 Assembling the engine intake system

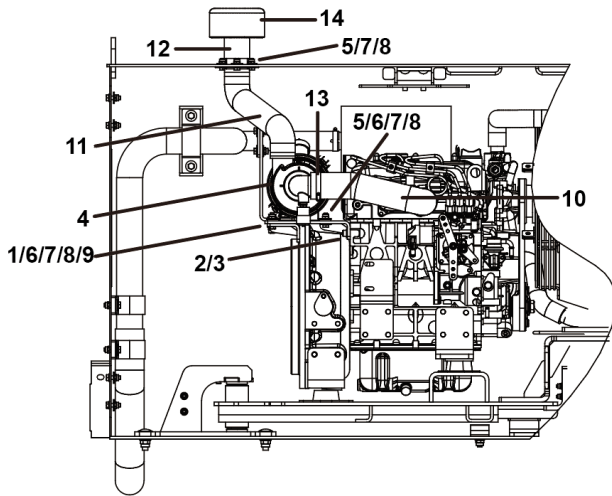

Fig. 3.39 Engine intake system

1. Air cleaner bracket 2. Screw 3. Washer 4. Air cleaner 5. Bolt 6. Washer 7. Washer 8. Nut 9. Bolt 10. Engine intake hose 11. Intake bellows 12. Transition pipe weldment 13. Hose clamp 14. Air pre-cleaner
1. Fix the part 1 to the engine housing with part 2 and part 3, and tighten it;
 2. Fix the part 4 to the air cleaner bracket with parts 5, 6, 7, 8 and 9, with bolt (part 9) used at the rear, bolt (part 5) used at the front, and part 6 used for the long hole;
 3. Fix the two bolts shared by the air cleaner support plate weldment and the pump cover, and tighten them to the specified torque; during installation, adjust the air cleaner to make its dust outlet downward.
 4. Fix the part 12 to the top of engine housing with parts 5, 7 and 8, and tighten them to the specified torque with washers installed on both sides;
 5. Sleeve the part 14 onto the part 12, insert part 12 to the limit for a depth of (25 ± 3) mm/ (0.98 ± 0.12) in, and then fasten it with the self-contained hose clamp of part 14;
 6. Connect the part 11 to the part 12 and the air inlet of air cleaner, and fix it with part 13 after

both ends are inserted to the bottom;

7. Connect the part 10 to the air outlet of the air cleaner and the air inlet of the engine, and then fix it with part 13 after both ends are inserted to the bottom;

Reference torque of part 2: 70 ± 5 N.m; reference torque of part 5 and part 9: 28 ± 3 N.m; tightening torque of pump cover bolt: 52 ± 5 N.m; tightening torque of self-contained hose clamp of part 13 and part 14: $5-5.5$ N.m;

Tools: electric wrench, hexagon socket wrench, socket wrench, open-end wrench, ratchet torque wrench, torque wrench

3.5.6 Removing the engine intake system

See Fig.3.39

1. Push out the engine pallet and fix it to prevent it from sliding.
2. Remove the self-contained hose clamp of the air pre-cleaner, and remove the air pre-cleaner;
3. Remove parts 5/7/8 and then part 12;
4. Remove the hose clamps at both ends of part 11, and then remove the part 11;
5. Remove the fastening bolts on the air cleaner bracket and air cleaner, remove the hose clamps at both ends of part 10, and remove the air cleaner.

3.5.7 Assembling the engine cooling system

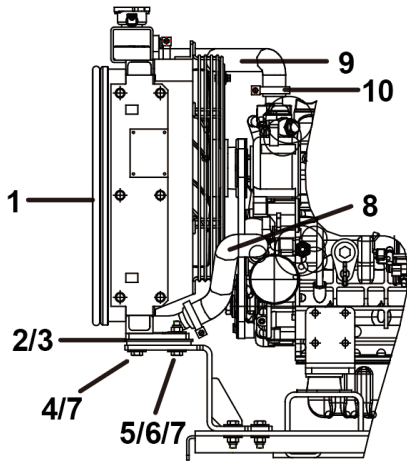

Fig. 3.40 Engine cooling system

1. Radiator assembly 2. Fixing plate 3. Rubber plate 4. Bolt 5. Washer 6. Bolt 7. Nut 8. Engine water inlet pipe 9. Engine water outlet pipe 10.

Hose clamp

1. Undo the self-contained bolts on the radiator fan shroud, and remove the radiator fan shroud;
2. Place the two parts 2 together on part 3, flatten the part 3 and place it on the radiator bracket, assemble part 1 on part 2 with parts 4, 5, 6 and 7, and tighten them to the specified torque;
3. Connect the part 9 to the radiator water inlet and the engine water outlet, and fix it with part 10 after both ends are inserted in place;
4. Connect the part 8 to the radiator water outlet and the engine water inlet, and fix it with part 10 after both ends are inserted in place; after installation, ensure that parts 8 and 9 are not twisted or stressed, and involve no interference with surrounding parts.

Tightening torque of part 4 and part 6: $32\pm 3\text{N.m}$; reference torque of shroud bolt: $28\pm 3\text{N.m}$; tightening torque of part 10: $5\text{-}5.5\text{N.m}$;

Tools: electric wrench, socket wrench, open-end wrench, ratchet torque wrench, torque wrench.

3.5.8 Removing the engine cooling system

See Fig.3.40

1. Push out the engine pallet and fix it to prevent it from sliding.
2. Loosen the hose clamps at both ends of part 9;
3. Loosen the hose clamps at both ends of part 8;
4. Attach the radiator assembly to the lifting equipment;
5. Remove the fastener at the bottom of radiator assembly;
6. Remove the fixing plate and rubber plate;
7. Remove the radiator assembly from the machine.

3.6 Fuel tank and hydraulic oil tank

3.6.1 Removing the fuel tank

 **WARNING: Risk of explosion and fire.**

Engine fuel is combustible. Perform this procedure in an open, well-ventilated area away from heaters, sparks, flames, and fireworks. Acceptable fire extinguishers shall be always placed in easily accessible places.

 **WARNING: Risk of explosion and fire.**

When delivering fuel, connect a ground wire between the machine and the pump or container.

 **WARNING: Risk of explosion and fire.**

Do not drain or store fuel in open containers due to possible fire.

1. Turn the start switch to "Ground Control" position, and then press the red emergency stop buttons on the GCU and PCU to "ON".
2. Start the engine and lift the platform above

the ground as appropriate.

3. Raise the safety arm slightly and rotate it to the vertical position. Lock the safety arm in place.

⚠ Caution:

Ensure that the safety arm is locked in the vertical position.

4. Lower the platform to the safety arm. Shut down the engine.

⚠ Risk of crushing.

When lowering the platform, do not touch the safety arm with your hands.

5. Mark, disconnect and plug the fuel supply and return hoses.
6. Remove the fuel filler cap from the fuel tank.
7. Remove the drain plug at the bottom of the fuel tank, and drain the fuel into a suitable container.

⚠ WARNING: Risk of explosion and fire

When delivering fuel, connect a ground wire between the machine and the pump or container.

⚠ Caution:

Ensure that only manual pumps suitable for gasoline and/or diesel are used.

8. Remove the fasteners 2, 3, 4 and 5 that fix the fuel tank.

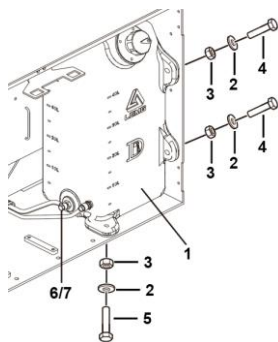

Fig. 3.41 fuel tank

1. Rolling plastic fuel tank assembly 2. Washer 3.

Nut 4. Bolt 5. Bolt 6. Bolt 7. Washer

9. Support the fuel tank and fix it to appropriate lifting equipment.
10. Remove the fuel tank from the machine.

⚠ Risk of part damage.

The fuel tank is plastic and may be damaged if dropped.

Note: Before installation, please clean the fuel tank and check for cracks and other damage.

3.6.2 Installing the fuel tank

1. Install part 1 to the rear of the tank side, as shown in the Fig., use parts 2, 3, 4 and 5 to fix it; install part 5 at the bottom, install part 4 on the side, install the bolts from the outside to the inside of the tank, and gaskets on both sides, and tighten them to the specified torque;
2. Connect the fuel pipe 7 from the return port of the engine to the interface without filter element at the front of the fuel tank, connect the fuel pipe 1 from the inlet of the primary filter to the interface with filter element at the rear of the fuel tank, fix them using one part 6 and two part 7, and then tighten them to the specified torque;

Tightening torque of parts 4/5: 40±4N.m;

Tightening torque of part 6: 37±4N.m

Tools: electric impact wrench 51082, socket wrench 1/2-16mm, open-end wrench 13-16, torque wrench QSP100, socket wrench 1/2-19mm.

3.6.3 Removing the hydraulic tank

⚠ Risk of part damage.

The working area and surface for performing this procedure must be clean. If debris enters the hydraulic system, serious damage may be caused to the components.

Therefore, it is recommended that this service is performed by dealers.

The O-rings (if any) of the fittings and/or hoses must be replaced. During installation, all connections must be tightened to the specified torque. Please refer to torque specifications of hydraulic hoses and fittings.

1. Remove the GCU and put it aside;
2. Remove the fastener of inclinometer, remove the inclinometer and put it aside;
3. Open the ball valves on the hydraulic tank.
4. Remove the drain plug from the hydraulic tank, and completely drain hydraulic oil into a suitable container.

CAUTION: Risk of part damage.

The engine shall not be started when the valve of the hydraulic tank is closed, otherwise parts may be damaged. If the valve is closed, remove the key from the start switch and put a label on the machine to inform related personnel.

5. Mark, disconnect and plug the suction pipes connected to the ball valves of hydraulic tank.
6. Disconnect the fittings on the hydraulic tank and the hose connected to it.
7. Remove the fasteners that fix the hydraulic tank.
8. Support the hydraulic tank and attach it to an appropriate lifting equipment.
9. Remove the hydraulic tank from the machine.

WARNING: Risk of crushing.

If not properly supported and fixed on the lifting equipment during removal from the machine, the hydraulic tank may be out of balance and fall off.

3.6.4 Installing the hydraulic oil tank

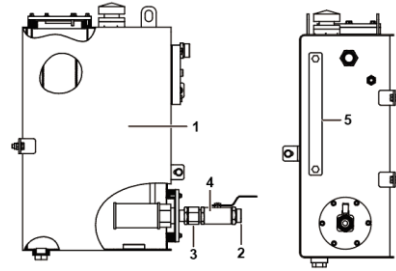

Fig. 3.42 hydraulic oil tank

1. Hydraulic tank delivery assembly
2. Straight fitting
3. Transition joint
4. Ball valve
5. Level gauge

1. Remove the oil tank suction flange interface protection, install the part 3 to the oil suction flange interface, and tighten it to the specified torque.
2. Install part 4 to part 3, and tighten it to the specified torque;
3. Install part 2 to part 3, and tighten it to the specified torque;
4. Install part 2 to the hydraulic oil tank with the bolts provided with the level gauge, and tighten it to the specified torque.

Tightening torque of part 3 and 2 ball valve connection end: 195±20N.m; tightening torque of part 3 oil suction flange end: 135±14N.m; tightening torque bolt comes with level gauge: 23±2N.m.

Tools: torque wrench SP310*41, torque wrench SP160*41, open-end wrench 41-46, ratchet torque wrench QSP50N3, socket wrench 3/8 16mm

3.7 Wheels

3.7.1 Removing wheels

1. Unscrew the wheel nuts, but do not remove them .
2. Block the non-steered wheel, and place a jack with sufficient bearing capacity under the steering axle.

3. Raise the machine by 15 cm/5.9in, and place a cushion block under the chassis for the purpose of supporting.

 **CAUTION:** Risk of crushing.

If improperly supported, the machine may fall.

4. Unscrew the wheel nuts and remove the wheel.

3.7.2 Assembling wheels

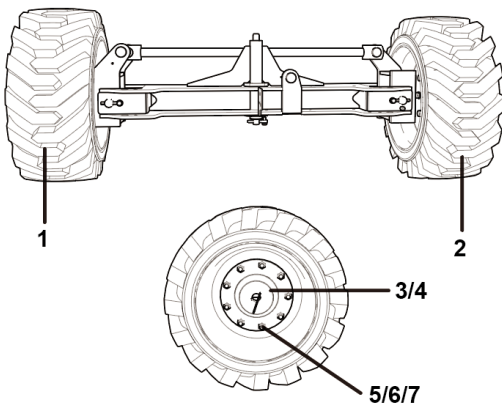

Fig. 3.43 Assembling the front wheel

1. Tire assembly 26×12-16.5-10 (left) 2. Tire assembly 26×12-16.5-10 (right) 3. Adapter board
4. Cotter pin 5. Hexagon cone nut 6. Bolt 7.

Washer

1. Remove the slotted nut that comes with the front axle motor, install parts 1 and 3 to the left side of the front axle motor, install part 3 on the outer side of the tire, and then tighten the removed slotted nut and fix it with part 4;
2. Use parts 5, 6 and 7 to fix the tire and the adapter board, and tighten them to the specified torque;
3. The assembly method for the right tires and the left tires is the same;

Tightening torque of part 6: 305±25N.m; tightening torque of self-contained nut of motor: 410-540N.m

Tools: pneumatic wrench MI-18, pointer torque wrench (0-1000N.m), torque wrench QSP420N, socket wrench 3/4-24mm, 3/4" series hexagon

pneumatic socket wrench 42mm, adapter 1-3/4, extension rod 3/4-150mm, open-end wrench 22-24

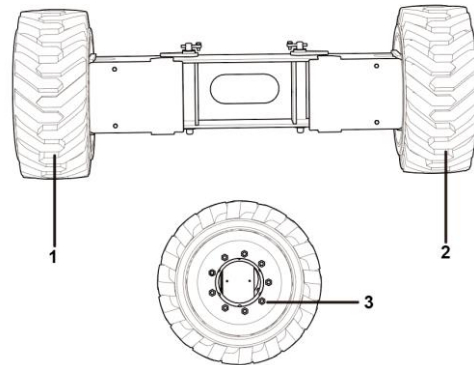

Fig. 3.44 Assembling the rear wheel

1. Tire assembly (left) 2. Tire assembly (right) 3. Hexagon cone nut

6. Install parts 1 and 2 to the left and right sides of the rear axle respectively, and fasten them with parts 3;

Tightening torque of part 3: 305±25N.m;

Tools: pneumatic wrench MI-18, torque wrench QSP420N, socket wrench 3/4-24mm, socket wrench 1/2 -24mm

3.8 Front axle assembly

3.8.1 Installing the steering rod and steering cylinder

1. Use parts 2, 3 and part 4 to assemble part 1 and steering cylinder to the position of front axle weldment and steering knuckle as shown in the Fig..
2. One end of the pin with a hole is located below, and part 4 should be placed between part 3 and the steering rod or steering cylinder; the cotter pin needs to be bent not less than 180° to both sides after installation.
3. Connect part 5 to the right-angle joint above the large cavity on the left side of the steering cylinder, and tighten it to the specified torque;
4. Connect part 6 to the right-angle joint under the small cavity on the right side of the steering cylinder, and tighten it to the specified torque; the unconnected end of part

5 is marked S1, and the unconnected end of part 6 is marked S2.

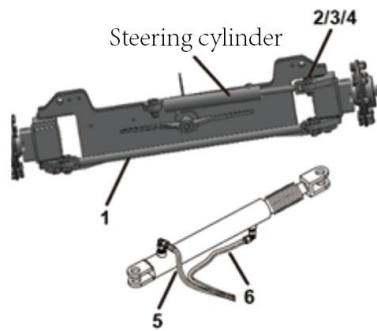

Fig. 3.45 Installing the steering rod and steering cylinder

1. Steering rod 2. Tie rod pin 3. Cotter pin 4. Washer 5. Hose 6. Hose

Tightening torque of parts 5/6: $22 \pm 2 \text{N.m}$;

Tools: needle-nosed pliers, torque wrench SP67*17

3.8.2 Removing the steering linkage and steering cylinder

! Caution:

The O-ring (if any) of the removed fitting and hose assembly must be replaced. During installation, all connections must be tightened to specified torque. Please refer to the specification for selection of tightening torque of the lifting platform.

1. Block the non-steering tires to prevent them from moving.
2. Mark, disconnect and plug the hydraulic hose of the steering cylinder. And cover the fittings on the cylinder.
3. Remove the fasteners that fix the cylinder rod end pin. Remove the pin.
4. Remove the fasteners that fix the cylinder tube end pin. Remove the pin.

! Caution:

When removing the fasteners, be sure to record the number and location

of the removed washers.

5. Remove the steering cylinder from the machine.
6. Remove the fasteners that fix the pins on both ends of the steering linkage. Remove the pin.
7. Remove the steering linkage from the machine.

! Danger:

Splashed hydraulic oil may penetrate and burn the skin. Therefore, please loosen hydraulic connectors very slowly to reduce the oil pressure gradually. Avoid hydraulic oil from splashing

! Caution: Risk of part damage.

If being kinked or squeezed, the hoses may be damaged.

3.8.3 Installing the steering knuckle and front motor

1. Assemble the left and right steering knuckles to the front axle, and fix them with part 1. The round hole ends of part 1 are respectively located on the sides of the front axle and steering knuckle mounting plates;
2. Fix part 1 with parts 2, 3 and 4, and install part 2 on the side of the front axle mounting plate; tighten them to specified torque;
3. Install parts 9 to the A and B ports of part 5, tighten them to specified torque;
4. Use parts 6, 7 and 8 to assemble part 5 to the front axle and steering knuckle, and tighten them to specified torque; apply AT262 thread locker before part 6 is installed; install the bolts from the inside to the outside, and install the washer on the nut side.

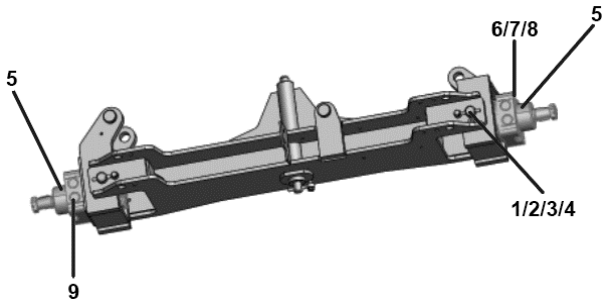

Fig. 3.46 Front axle components

1. Shaft
2. Latch
3. Bolt
4. Washer
5. Traveling motor
6. Screw
7. Washer
8. Nut
9. Extended fitting

Reference torque of part 3: $52 \pm 5 \text{N.m}$;
 tightening torque of part 6: $120 \pm 10 \text{N.m}$;
 tightening torque of part 9: $34 \pm 3 \text{N.m}$

Thread locker applying method: Apply 3~5 threads from the second thread of the threaded;

Tools: electric impact wrench (SATA 51073), assembled copper bar, ratchet wrench 1/2-16mm, torque wrench QSP200, open-end wrench 16-18, torque wrench QSP50N3, ratchet wrench 1/2-19mm, adapter 3/8 -1/2

3.8.4 Removing the steering knuckle and front axle motor

1. Lock the steering wheels and place the jack in the middle of the steering end of the chassis (i.e., the front axle).
2. Unscrew the wheel nuts, but do not remove them.
3. Raise the machine 5cm. Place the bracket under the chassis for the purpose of supporting.

 **CAUTION: Risk of crushing.**

If not supported, the chassis may fall.

4. Remove the wheel nuts to remove the tires.
5. Remove the fasteners that fix the pipe clamp of the walking motor, and then remove the

pipe clamp.

6. Remove the mounting fasteners of the oil pipe bracket, and remove the oil pipe bracket from the steering knuckle.
7. Mark, disconnect and plug the hose of the walking motor. Cover the fittings on the walking motor.

 **WARNING: Risk of personal injury.**

Splashed hydraulic oil may penetrate and burn the skin. Therefore, please loosen hydraulic connectors very slowly to reduce the oil pressure gradually. Prevent the oil from spraying or splashing.

8. Use a jack to support and fix the steering knuckle and walking motor.
9. Remove the cotter pin on the steering linkage.
10. Remove the fasteners that fix the steering linkage pin from the steering cylinder, and then remove the pin, as shown in the Fig. below:
11. Remove the fasteners of the lower king pin of the steering knuckle, and then remove the lower king pin.

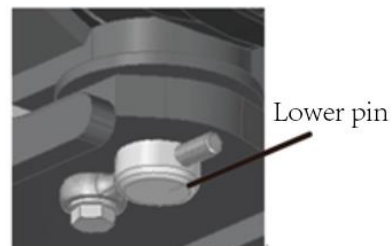

Fig. 3.47 Lower pin

12. Remove the fasteners of the upper king pin of the steering knuckle, and then remove the upper king pin;

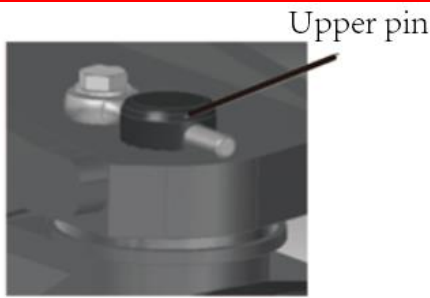

Fig.3.48 Upper pin

- Remove the walking motor and steering knuckle.

⚠ CAUTION: Risk of crushing.

If not supported during removal, the steering knuckle and walking motor may be out of unbalance or fall off.

3.8.5 Assembling the axle swing cylinder

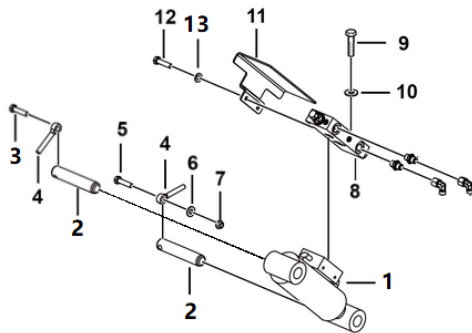

Fig. 3.48 Assembling the floating cylinder

1. Floating cylinder 2. Shaft 3. Bolt 4. Safety pin 5. Bolt 6. Washer 7. Nut 8. Floating balance valve 9. Bolt 10. M8 hard gasket 11. Floating valve mounting plate 12. Bolt 13. Washer
- Assemble part 1 to the left and right sides of the front axle with part 2; tighten the part 2 at the upper part with part 3 and part 4 to the specified torque; tighten the part 2 at the lower part with part 4, part 5, part 6 and part 7 to the specified torque; install part 4 at the front side of the machine;
 - Remove the self-contained protective plate on the floating cylinder, clean the paint slag on

the mounting surface of valve block, assemble part 8 onto part 1 with part 9 and part 10, and tighten it to the specified torque; (Note: the oil pipe interfaces of valve bodies on both sides should face backward).

- Assemble part 11 to part 1 with parts 12 and 13, and tighten it to the specified torque;

Reference tightening torque of part 3 and part 5: $52 \pm 5 \text{N.m}$; tightening torque of part 9: $33 \pm 3 \text{N.m}$; tightening torque of part 12: $28 \pm 3 \text{N.m}$;

Tools: ratchet torque wrench, electric wrench, socket

3.8.6 Removing the axle swing cylinder

⚠ Caution:

The O-ring (if any) of the removed fitting and hose assembly must be replaced. During installation, all connections must be tightened to specified torque. Please refer to the specification for selection of tightening torque of the lifting platform.

- Mark, disconnect and block the hydraulic hose, and cover the fittings;
- Attach the floating cylinder to the lifting equipment;
- Remove the fasteners that fix the shafts at the upper and lower ends of the floating cylinder, and remove the shaft;
- Remove the fasteners that fix the floating valve mounting plate, and remove the floating valve mounting plate;
- Remove the fasteners that fix the floating valve, and remove the floating valve;
- Remove the floating cylinder from the machine.

3.9 Rear axle assembly

3.9.1 Installing the reducer

1. Install the reducer to the left and right mounting plates of the rear axle with parts 2 and 3 respectively, and tighten it to the specified torque.

CAUTION:

Before installing the reducer, it is necessary to install part 4 at the brake fluid port, and the part 4 must not be squeezed; apply AT262 thread locker before installing the screw;

Note that the following requirements shall be met for the assembly of the reducer:

- 1) The reducer shall be installed to the left rear axle housing in such a way that the threaded hole of the walking motor shown in Fig. 3.49 is approximately 45° diagonally upward and the service brake fluid port shown in Fig. 3.49 is approximately 45° diagonally downward;
- 2) The reducer shall be installed to the right rear axle housing in such a way that the threaded hole of the walking motor shown in Fig. 3.49 is approximately 45° diagonally downward and the service brake fluid port shown in Fig. 3.49 is approximately 45° diagonally upward;

Thread locker applying method: Apply 3~5 threads from the second thread of the threaded;

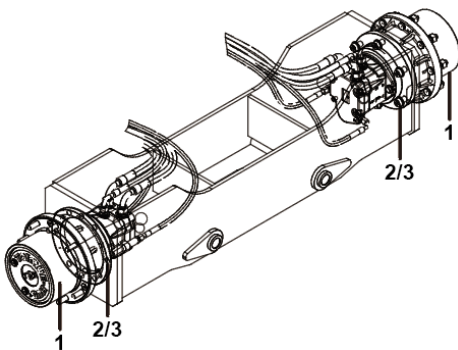

Fig. 3.49 Installing the reducer

1. Reducer 2. Screw 3. Washer 4. O-ring

Tightening torque of part 2: 280±28 N.m.

Tools: torque wrench QSP420N, hexagon head socket wrench 12mm, electric impact wrench (SATA 51073)

3.9.2 Installing the rear axle motor

1. Install the walking motor to the walking reducer with parts 1 and 2 after installing the O-ring (part 3) to the mating surface and checking that the O-ring of service brake fluid port is in place, and tighten it to the specified torque;

Caution:

1. Do not damage the O-ring;
2. Coat part 1 with AT262 thread locker before installing it;
3. Thread the bolt from inside out to prevent interference between the steel pipe and the bolt!
4. The brake fluid port of the motor corresponds to the position of the brake fluid port of the reducer.

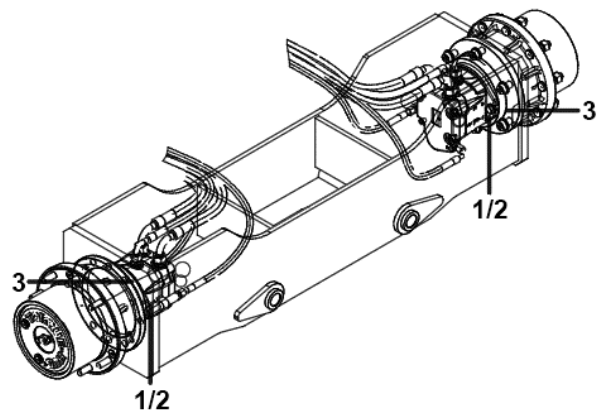

Fig. 3.50 Installing the rear axle motor

1. Bolt 2. Washer 3. O-ring

Tightening torque of part 1: 100±10N.m

Thread locker applying method: Apply 3~5 threads from the second thread of the threaded;

Tools: pneumatic wrench MI-12, ratchet wrench 1/2 16mm, torque wrench QSP200, AT262 thread locker (on demand)

3.9.3 Removing the rear axle assembly

CAUTION: Risk of part damage.

The motor maintenance shall only be performed by the dealers.

CAUTION: Risk of part damage.

The working area and surface where this step is performed must be clean, and no impurities will enter the hydraulic system, which may cause serious component damage. It is recommended that the dealer perform maintenance.

CAUTION:

Before refitting, the O-ring of the removed fitting and/or hose assembly must be replaced and then tightened to the specified torque. Please refer to hydraulic hose and fitting torque specifications.

1. Lock the steered wheel.
2. Mark, disconnect and plug the hydraulic hose of walking motor.

WARNING: Risk of personal injury.

Splashed hydraulic oil may penetrate and burn the skin. Therefore, please loosen hydraulic connectors very slowly to reduce the oil pressure gradually. Do not spray or splash oil.

3. Remove the fasteners of the walking motor.
4. Pull out the walking motor shaft from the reducer, and remove the walking motor from the machine.

CAUTION:

An O-ring is installed between the walking motor and the reducer. When installing the walking motor to the machine, make sure that the O-ring is in the correct position.

5. Lock the steered wheel and place the jack in the middle of the steering end of the chassis.
6. Unscrew the wheel nuts, but do not remove them.
7. Raise the machine by 5 cm. Place the bracket under the chassis for the purpose of supporting.
8. Unscrew the wheel nuts and remove the tires.
9. Place another jack under the reducer to support and fix the reducer.
10. Remove the fasteners of the reducer and then remove the reducer.

3.10 Outrigger assembly

3.10.1 Assembling the outrigger cylinder

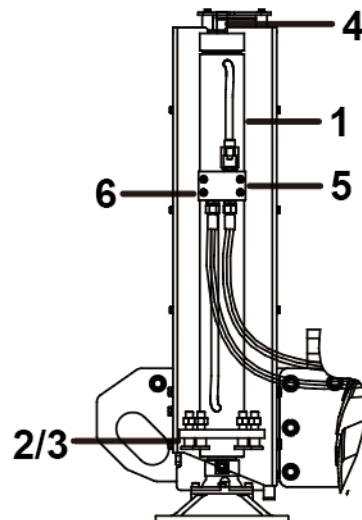

Fig. 3.51 outrigger cylinder

1. Outrigger cylinder
 2. Outrigger cylinder mounting bolt
 3. Nut
 4. Outrigger cylinder guide stud
 5. Outrigger solenoid valve
 6. Screw
1. Install part 1 to the mounting positions on both sides of the support beam with parts 2 and 3,

- and tighten it to the specified torque; apply AT262 thread locker to bolts before installation;
2. Install part 4 to the mounting hole on the upper part of the outrigger cylinder and tighten it;
 3. Remove the protective plate which is provided at the mounting position of the cylinder valve block, clean up the paint slag on the mounting surface of the valve block, etc., use part 6 to install part 5 to the outrigger cylinder and tighten it to the specified torque as shown. Apply AT262 thread locker on part 6 before installation.

Note : That the Fig. 3.51 only shows the installation of one cylinder, and the installation method for other cylinders is the same and will not be described again;

Tightening torque of part 2: $125\pm 13\text{N.m}$;
tightening torque of part 6: $33\pm 3\text{N.m}$;
tightening torque of part 4: $145\pm 15\text{N.m}$;

Tools: ratchet torque wrench QSP50N3, 3/8" S6 hex bit socket, 1/2" hexagon head socket wrench 12, torque wrench QSP200, open-end wrench 18-21

3.10.2 Removing the outrigger cylinder

Caution:

Before refitting, the O-ring of the removed fitting and/or hose assembly must be replaced and then tightened to the specified torque. Please refer to hydraulic hose and fitting torque specifications.

Caution:

This procedure should be implemented when the platform and the outrigger are retracted.

1. Remove the outrigger cylinder support.
2. Remove the fasteners that fix the outrigger cover, and then remove the outrigger cover.
3. Mark and disconnect the wiring of the

outrigger cylinder solenoid valve.

4. Mark, disconnect and plug the hydraulic hose of the outrigger cylinder. Cover the fittings on the cylinder.

WARNING: Risk of personal injury.

Splashed hydraulic oil may penetrate and burn the skin. Therefore, please loosen hydraulic connectors very slowly to reduce the oil pressure gradually. Do not spray or splash oil.

5. Connect the sling of the crane to the barrel end of the outrigger hydraulic cylinder, and do not apply any force.
6. Remove the fasteners that fix the outrigger cylinder, and remove the outrigger cylinder from the machine.

WARNING: Risk of crushing.

If not properly supported during removal, the outrigger cylinder may be out of balance or fall off.

CAUTION:

To replace the outrigger cylinder, remove the outrigger cylinder guide stud from the barrel end of the outrigger cylinder and install it on the new cylinder.

3.10.3 Installing the level meter

1. Use parts 4, 5, 6 and 3 to assemble part 2 to be above the right front outrigger weldment and tighten it;
2. Assemble the level meter to the mounting plate with the screws and nuts provided with the level meter (for subsequent adjustment and leveling); tighten the part 4 until the cushion block is slightly deformed, and the screws and nuts provided with the level meter should not interfere with the outrigger

weldment! The scale of the level meter is separated front, rear, left, and right; as shown in the Fig. on the right.

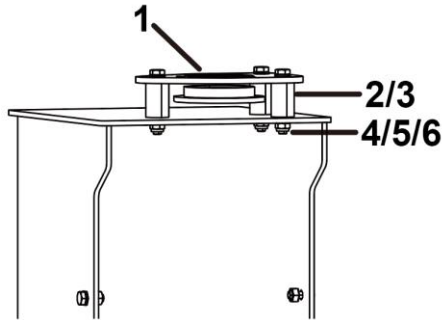

Fig. 3.52 Installing the level meter

1. Shanghai Yunshen level gauge
2. Mounting plate weldment
3. Cushion block
5. Nut
6. Washer

Tools: ratchet torque wrench QSP50N3, 3/8" S6 hex bit socket, 3/8" S6 hex bit socket, hexagon head socket wrench 1/2-8mm, ratchet torque wrench QSP100N, open-end wrench 13-16

Note: The disassembly process of simple components should be carried out in the reverse order of the assembly process without detailed description.

3.11 Other components

3.11.1 Installing the hydraulic oil radiator

1. Assemble part 2 to the outside of the rear panel of the left case body using parts 3, 4 and 5, and install and tighten the bolts from the outside to the inside;
2. Insert part 1 into part 2 from above, with the fan facing the case body, fasten the bolts from the outside to the inside using parts 4, 5, 6 and 7, and install large washers to the nut side;
3. Install parts 8 to the oil inlet and outlet of part 1, tighten them to the specified torque, then install part 9 to part 8, with part 9 facing the case body, and then connect and straighten

the pipeline and tighten them to the specified torque;

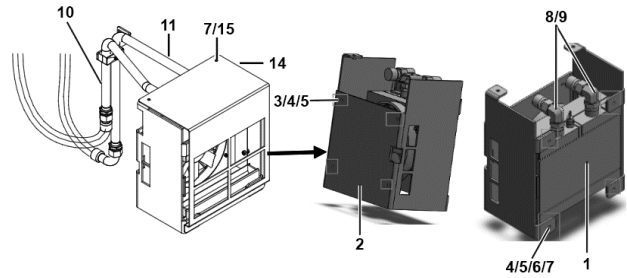

Fig. 3.53 the hydraulic oil radiator

1. Hydraulic oil radiator
2. Bracket plate weldment
3. Bolt
4. Washer
5. Nut
6. Bolt
7. Washer
8. Joint
9. Transition fitting
10. Oil return steel pipe assembly
11. Oil inlet steel pipe assembly
12. Pipe clamp mounting plate
13. Duplex double hole pipe clamp
14. Cover plate weldment
15. Bolt

Tightening torque of part 3/6: $28 \pm 3 \text{N.m}$;
tightening torque of parts 8/9: $135 \pm 14 \text{N.m}$;
Tightening torque of parts 10/11: $135 \pm 14 \text{N.m}$;
Tightening torque of part 15: $28 \pm 3 \text{N.m}$;

Tools: ratchet torque wrench QSP50N3, socket wrench 3/8-13mm, electric impact wrench 51082, socket wrench 1/2-13mm, open-end wrench 13-16, torque wrench SP160*41, Tools: ratchet torque wrench QSP50N3, socket wrench 3/8-13mm

4. Connect the end of the part 10 with a rotating nut to the joint at the oil return port of the radiator, with the other end facing downward;
5. Connect the end of the part 11 with a rotating nut to the joint at the oil return port of the radiator, with the other end facing downward;
6. Fasten the part 12 to the rear panel of the case body using parts 3, 4, and 7 in the direction as shown in the Fig. below, install bolts from the outside to the inside, and install part 7 to the nut side;
7. Fix parts 10 and 11 using parts 13, and install parts 5 and 7 to parts 12 and 13;

8. Tighten parts 9, 10 and 11 to the specified torque.
9. Install part 14 to the part 2, fasten the upper part with parts 15 and 7, and the lower part is shared with the radiator.

3.11.2 Installing the DC power switch

1. Pass the power switch base that comes with part 1 through the inner front side plate of the left case, pass the limit post through the positioning hole on the case, and install the mounting seats that come with part 2 and 5 to the base stud from the outside of the case (OFF right above, ON on the right side), install the attached reed and 2 nuts on the base stud in turn, and tighten them;
2. Put the knob on the base stud, with the white marking on the top, tighten it with the self-contained screw, and press the plug.

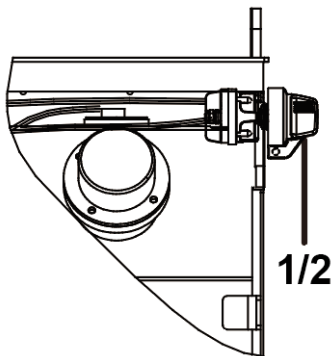

Fig. 3.54 DC power switch

1. DC power switch 2. Washer

Tools: lengthened hexagon pneumatic socket wrench 1/2-1, small Phillips screwdriver, manual ratchet wrench 3/8

3.11.3 Installing the high pressure filter

1. Install part 1 on the rear side of the rear panel of the engine case using parts 2, 3 and 4, install the bolts from the outside of the case inward, add the washer to the outside, and tighten it;
2. Install part 5 and part 6 to part 1, and tighten it; the direction of the filter oil circuit is shown

by the arrow; apply AT262 thread locker on part 6 before installation.

3. Install part 7 into the filter inlet and outlet respectively, and tighten it to the specified torque;
4. Install part 8 on the oil inlet and outlet part 7 of the filter, and tighten it to the specified torque vertically downwards.

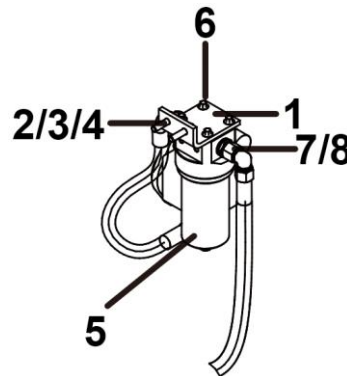

Fig. 3.55 high pressure filter

1. High pressure filter mounting plate 2. Bolt 3. Nut 4. Washer 5. High pressure filter 6. Bolt 7. Straight fitting 8. Joint

Reference tightening torque of part 6: $28 \pm 3 \text{N.m}$;

Tightening torque of part 2: $52 \pm 5 \text{N.m}$;

Tightening torque of part 7: $115 \pm 12 \text{N.m}$;

Tightening torque of part 8: $58 \pm 6 \text{N.m}$

Tools: electric impact wrench 51082, socket wrench 1/2-16mm, open-end wrench 13-16, socket wrench 1/2-10mm, torque wrench QSP200, socket wrench 1/2-27mm, torque wrench SP120NX27

3.11.4 Installing the battery

1. Clamp part 2 to the outside of part 1, and use parts 3, 4 and 5 to fasten to the front of the engine case side, as shown in the Fig.;

NOTE: The positive terminal of the battery is on the outside;

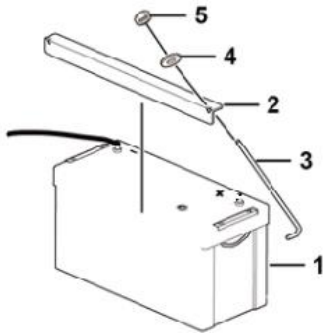

Fig. 3.56 battery

1. Battery 2. Locking angle steel 3. Threaded rod
4. Washer 5. Nut

Reference tightening torque of part 5: $12\pm 1\text{N.m}$;

**Tools: electric impact wrench 51082, long
socket wrench 1/2-13mm**

3.12 Valve group

3.12.1 Installing the spool

1. Immerse the spool in clean oil to lubricate the O-ring.
2. Manually screw in the spool until it reaches the top of the O-ring, and then adjust the torque to meet specification requirements.
3. If necessary, install the solenoid coil on the valve stem. Fix the coil to the valve stem with nuts and adjust the torque to meet the specification requirements.

3.12.2 Lift control valve

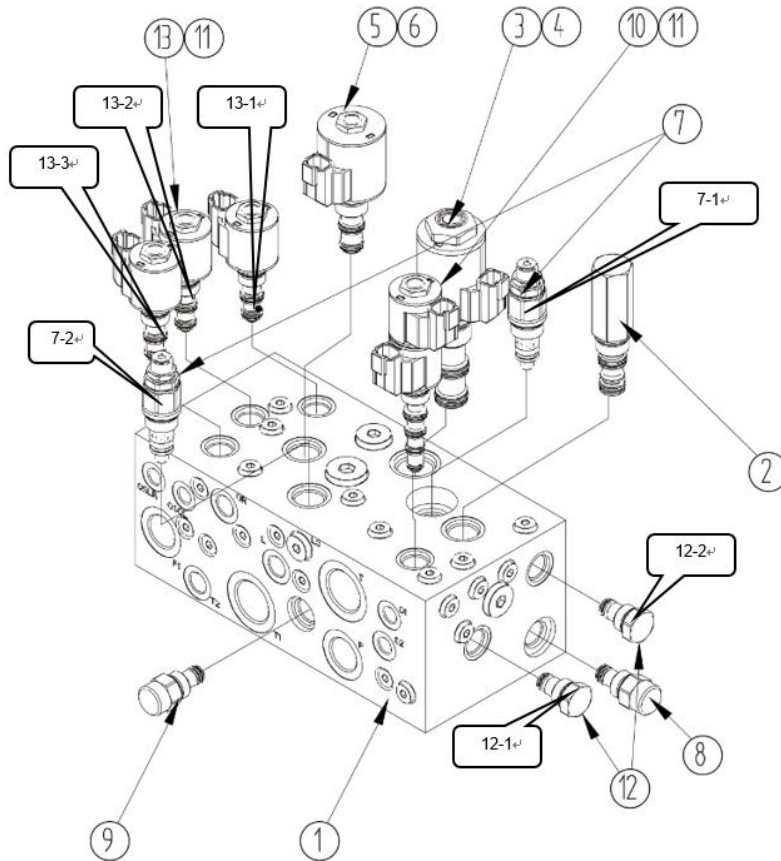

Fig. 3.57 Lift control valve

S/N	Name	Function	Pressure	Torque (Nm)
1	Valve block	-	-	-
2	Compensation valve	Preventing pressure build-up during steering	-	34-36
3	Solenoid valve	Controlling operation speed	-	47.4
4	Coil	-	-	4
5	On/off solenoid valve	Control lifting	-	33.9
6	Coil	-	-	4
7-1	Relief valve	Limiting the maximum pressure of the system	-	55-65
7 -2	Relief valve	Limiting the maximum pressure of the lifting system	-	55-65
8	Flow valve	Giving priority to ensuring steering flow	-	27.1
9	Flow valve	Preventing pressure build-up	-	33.9
10	Solenoid valve	Switching between left turn and right turn	-	27.1
11	Coil	-	-	4

12-1	Check valve	Restricting steering control oil flow direction	-	40-45
12 -2	Check valve	Restricting oil return direction of lift system and outrigger	-	40-45
13-1	Solenoid valve	Controlling floating	-	27.1
13-2	Solenoid valve	Controlling right floating	-	27.1
13-3	Solenoid valve	Controlling left floating	-	27.1

3.12.3 Walking control valve

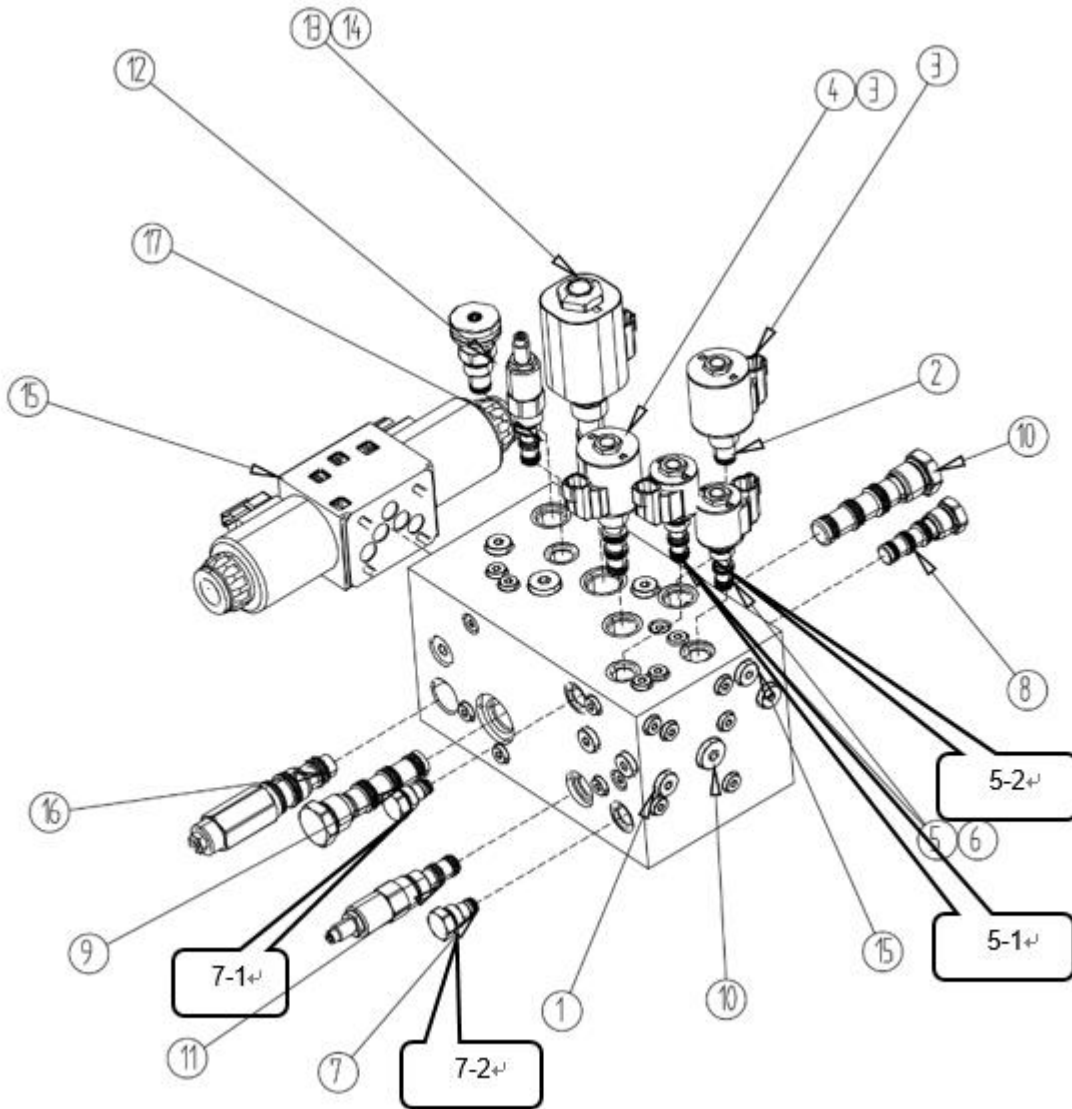

Fig. 3.58 Walking control valve

S/N	Name	Function	Pressure	Torque (Nm)
1	Valve block	-	-	-
2	Solenoid valve	Controlling operation mode of front axle motor	-	33.9
3	Coil	-	-	4
4	Solenoid valve	Controlling drive mode	-	33.9
5-1	Solenoid valve	Controlling high/low speed	-	27.1
5-2	Solenoid valve	Controlling braking	-	27.1
6	Coil	-	-	4
7-1	Check valve	Restricting two-speed oil inlet direction	-	40-45
7 -2	Check valve	Restricting braking oil inlet direction	-	40-45
8	Flow diverter/combiner valve	Distributing front motor flow as required	-	65-71
9	Flow diverter/combiner valve	Distributing rear motor flow	-	99-104

		as required		
10	Flow diverter/combiner valve	Distributing front/rear motor flow as required	-	99-104
11	Pressure relief valve	Controlling brake and governor pressure	-	33.9
12	Throttle valve	Controlling front axle motor flow	-	33.9
13	Solenoid valve	Controlling high-speed oil inlet	-	70-81
14	Coil	/	-	4
15	Solenoid valve	Controlling walking direction	-	15
16	Balance valve	Preventing braking impact	-	60-70
17	Two-way relief valve	Restricting walking pressure	-	27.1

3.12.4 Lower lift cylinder control valve

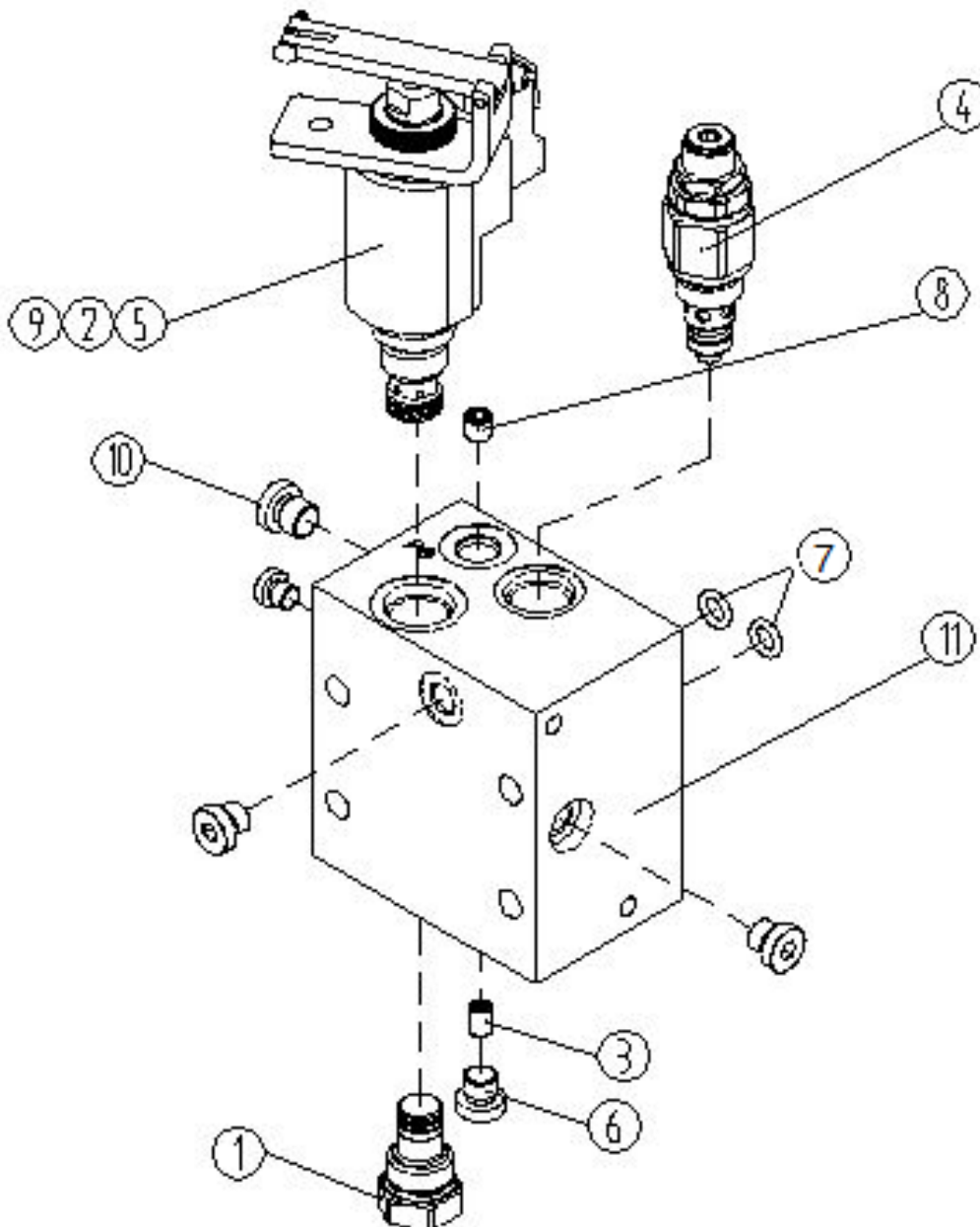

Fig. 3.59 Lower lift cylinder control valve

S/N	Name	Function	Pressure	Torque
-----	------	----------	----------	--------

1	Check valve	Enabling one-way flow of hydraulic oil	-	40-45
2	Proportional solenoid valve	Controlling the lowering speed	-	34-41
3	Damper	-	-	4
4	Overflow valve assembly	Limiting the maximum pressure of the lifting system	-	40-45
5	Coil	-	-	4
6	Plug	-	-	11-12
7	O-ring	-	-	4
8	M6 damper assembly	Avoid impacting the pressure sensor	-	4
9	Emergency mechanism	-	-	-
10	Plug	-	-	25-28
11	Valve block	-	-	-

3.12.5 Lower cylinder valve block

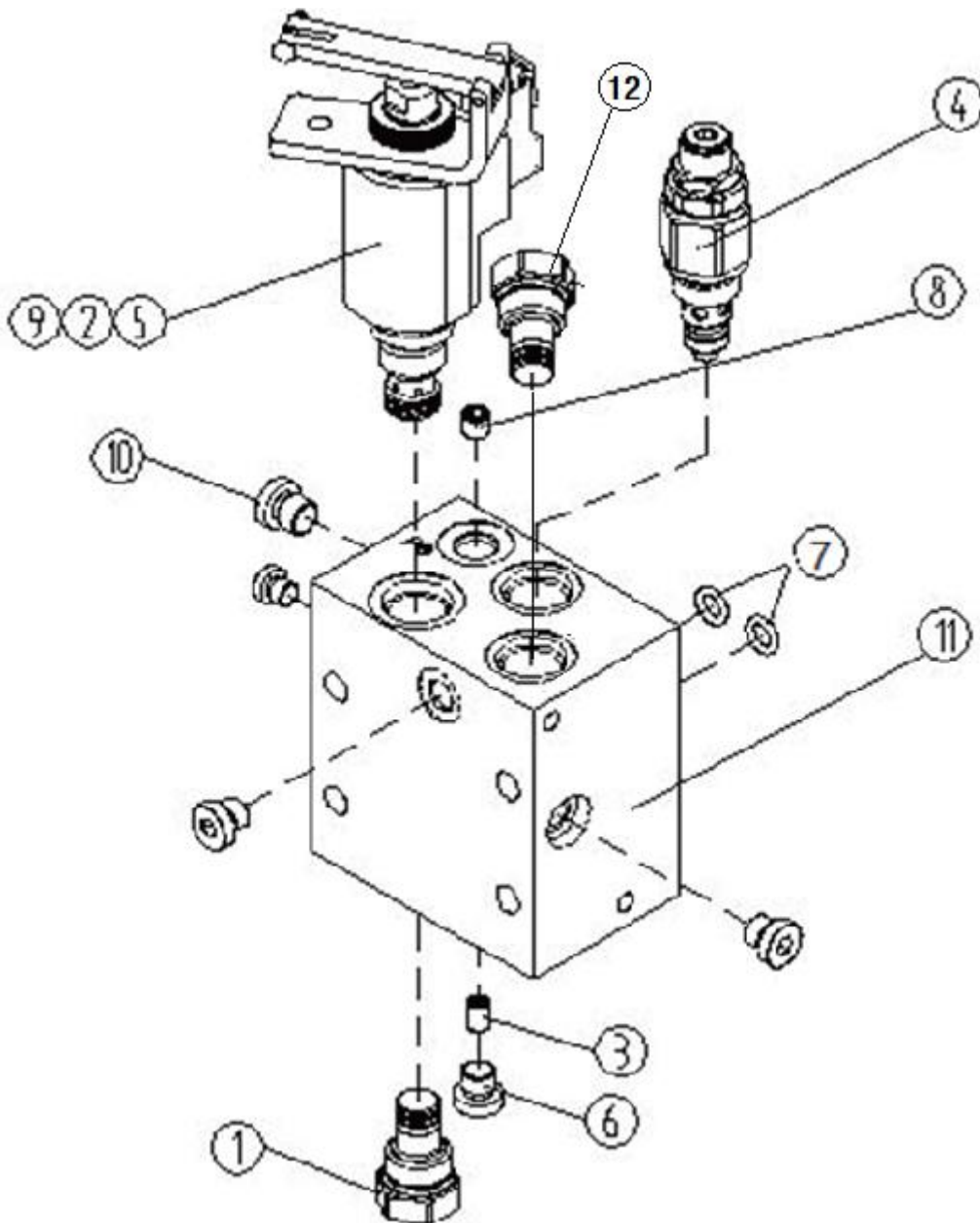

Fig. 3.60 Lower cylinder valve block

S/N	Name	Function	Pressure	Torque (Nm)
1	Check valve	Enabling one-way flow of hydraulic oil	-	40-45
2	Proportional solenoid valve	Controlling the lowering speed	-	34-41
3	Damper	-	-	2
4	Overflow valve assembly	Limiting the maximum pressure of the lifting system	-	40-45
5	Coil	-	-	4
6	Plug	-	-	11-12
7	O-ring	-	-	-
8	M6 damper assembly	Avoid impacting the pressure sensor	-	2
9	Emergency mechanism	-	-	-
10	Plug	-	-	25-28
11	Valve block	-	-	-
12	Check valve	Enabling one-way flow of hydraulic oil	-	40-45

3.12.6 Pressure sensor on lifting control valve

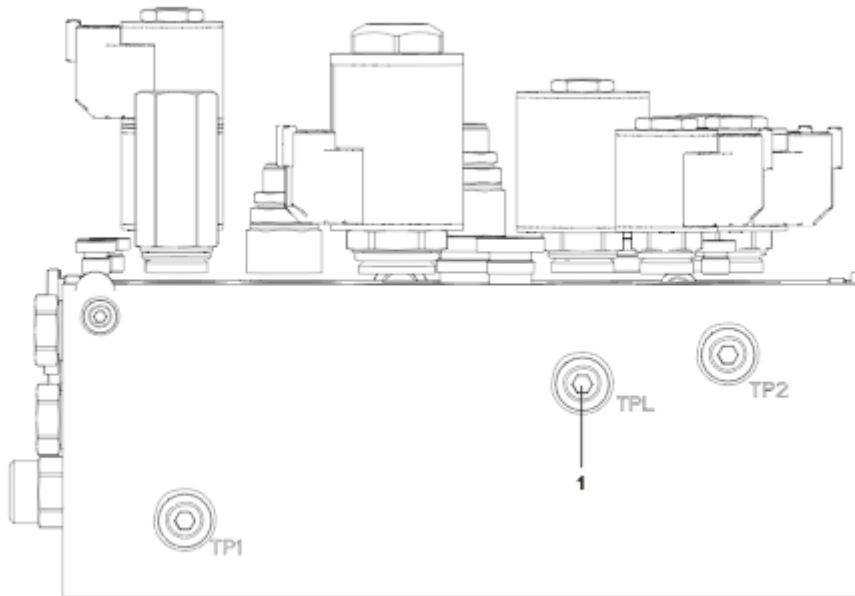

Fig. 3.61 Lift control valve

1. Installation position of pressure sensor

1. Assemble the pressure sensor at the TPL port of the lift control valve as shown. Pressure range: 0-250bar.

Tightening torque: 22±2Nm.

3.13 Schematic diagram of location of main appliances

For example SR0818D:

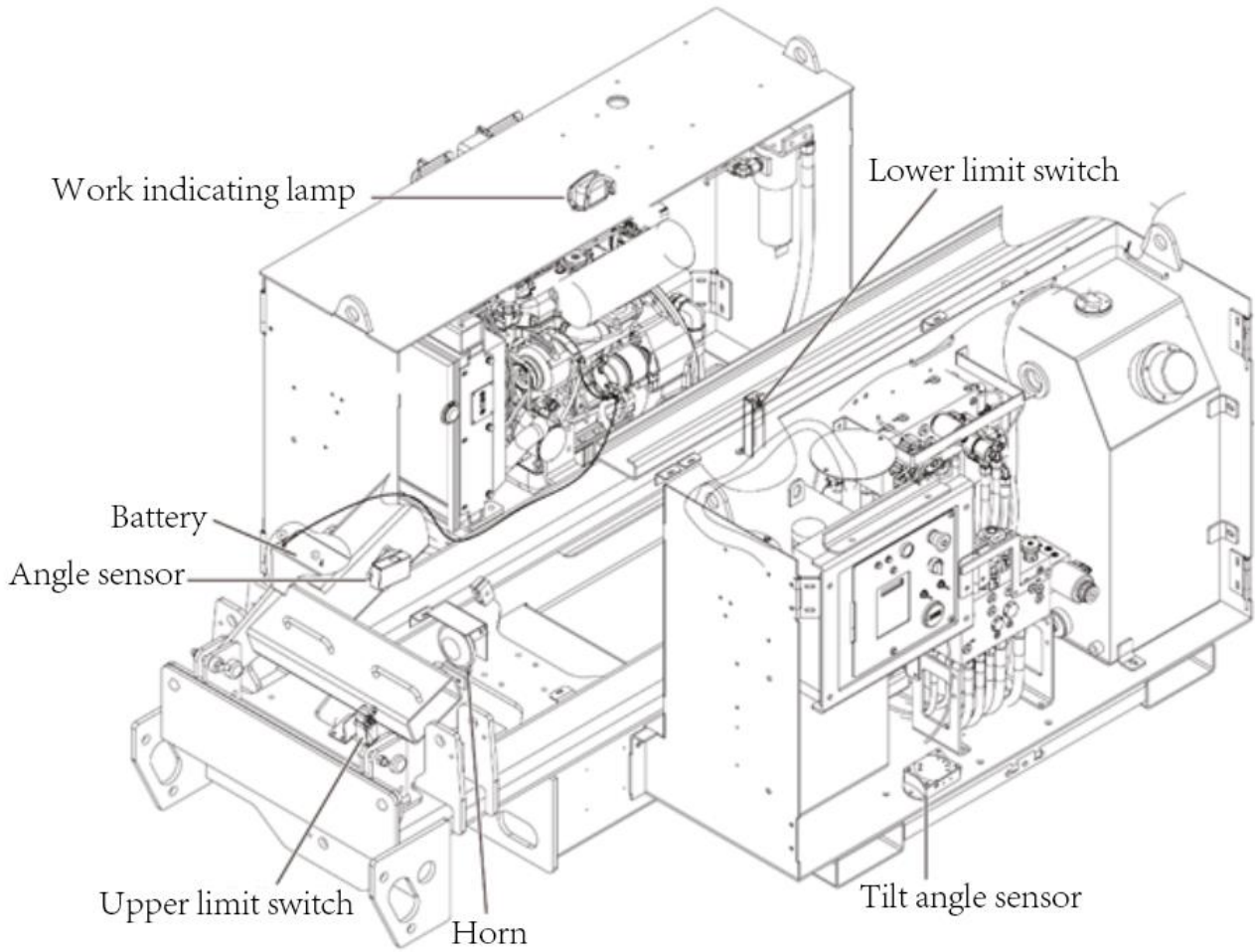

Fig. 3.62 Main electrical location map

4 Commissioning

4.1 Safety instructions

Before commissioning, please make sure to refer to the *Operation and Maintenance Manual*, familiarize yourself with the relevant safety precautions and basic operating requirements, and be particularly familiar with the following safety matters:

1. Alcoholics, drug users, and those taking inhibition reaction drugs are strictly prohibited to approach and operate the machine;
2. Before operating the machine, please ensure that you have worn protection equipment, such as helmet, safety belts (five-point), safety shoes, and you are in good physical condition;
3. The machine cannot be operated with the hood open. Before starting the engine, check the surrounding environment of the machine to ensure that no person works on the engine to avoid any danger during engine start. These instructions will not be repeated below;
4. Before operating the machine, sound the horn and check that there are no people or obstacles around, so as to avoid safety hazards to others, yourself, the machine or obstacles. Other people are not allowed to operate the machine during commissioning;
5. This machine is not insulated, and does not provide protection against electric shock when it is in contact with or near wires, power supplies or electrical equipment.



Please follow the applicable laws and regulations

and the instructions in the table below to maintain a sufficient safety distance from wires, power supplies, and electrical equipment.

Voltage	Required safety distance
0V~50KV	3.05m
50V~200KV	4.60 m
200V~350KV	6.10 m
350V~500KV	7.62m
500V~750KV	10.67m
750V~1000KV	13.72m

If the machine comes into contact with a live wire, stay away from the machine immediately. Before the power of the wire is cut off, personnel are forbidden to touch or operate the machine. Do not operate or use the machine during lightning or storms.

1. Do not raise the fork when the wind speed may exceed 12.5 m/s. If the wind speed exceeds 12.5m/s after the arm rod is raised, lower the fork and do not continue to operate the machine;
2. Do not operate the machine in strong winds or gusts. Do not increase the surface area of the platform or load. Enlarging the area exposed to the wind will reduce the stability of the machine;
3. Do not operate the machine via the PCU when the platform is tripped, stuck, or its normal movement is hindered by other objects nearby. If it is expected to operate the machine via the ground control unit, this operation can be done only after all personnel have left the platform;
4. Be extremely careful and reduce the speed when the machine runs in retracted state on gravel, unstable or smooth surfaces, near openings or steep slopes, etc.;
5. Do not sit, stand or climb on the protective guard of the platform. Stand steadily on the platform base plate at all times.

4.2 Test of basic functions

4.2.1 Start/stop test

1. Ground control mode: Turn the key to GCU position, and pull up the emergency stop button. In this case, the GCU LCD screen will display "System Ready";
Press and hold the ignition button on the ground control panel. When hearing the engine startup sound, release the button after 3s. Then the machine will be started;
Press the emergency stop button or turn the key switch to the neutral position, to shut down the engine.
2. Platform control mode: Turn the key to PCU position, and press the emergency stop buttons of PCU and GCU. In this case, the GCU LCD screen will display "System Ready";
Press and hold the ignition button on the platform control panel. When hearing the engine startup sound, release the ignition button after 3s. Then the machine will be started;
Press the emergency stop button to shut down the engine.

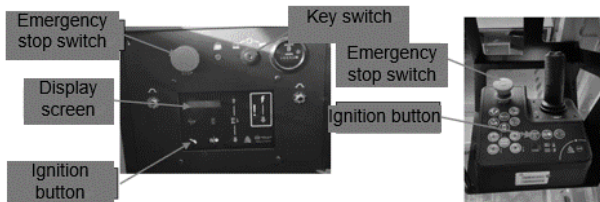

Fig. 4.1 Start/stop test

4.2.2 Lifting/lowering function test

1. Start the engine, and operate the control panel.
Do not press the lift switch, instead, press and hold the platform UP switch;
Control criteria: The platform isn't lifted.
2. Press and hold the lift switch and the platform UP switch;
Control criteria: The platform is lifted.
3. Press and hold the lift switch and the platform DOWN switch;

Control criteria: The platform is lowered, and the lowering alarm sounds.

4. Use PCU. Turn on the lifting joystick switch as indicated by the blue arrow;

Control criteria: The platform isn't lifted.

Press and hold the lift switch, and turn on the lifting joystick switch as indicated by the blue arrow;

Control criteria: The platform is lifted.

Press and hold the lift switch, and turn on the lowering joystick switch as indicated by the yellow arrow;

Control criteria: The platform is lowered, and the lowering alarm sounds.

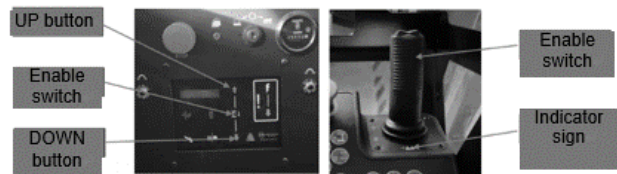

Fig. 4.2 Lifting/lowering function test

4.2.3 Steering test

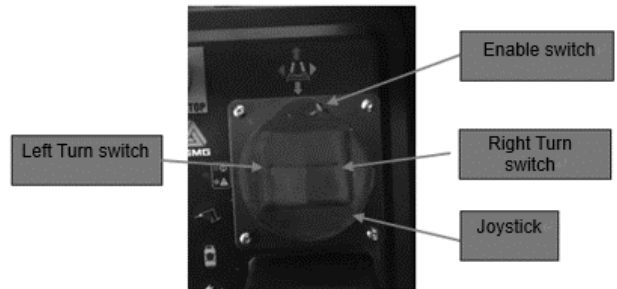

Fig. 4.3 Steering test

5. Press and hold the joystick function enable switch;
6. Operate the thumb joystick switch on the top of the joystick as indicated by the blue arrow on the control panel;

Control criteria: The steered wheel rotates as indicated by the blue arrow on the control panel.

7. Operate the thumb joystick switch on the top of the joystick as indicated by the yellow arrow on the control panel;

Control criteria: The steered wheel rotates as indicated by the yellow arrow on the control panel.

CAUTION: The tester shall stand in the middle of the platform and face toward the steering end of the machine under test.

4.2.4 Horn test

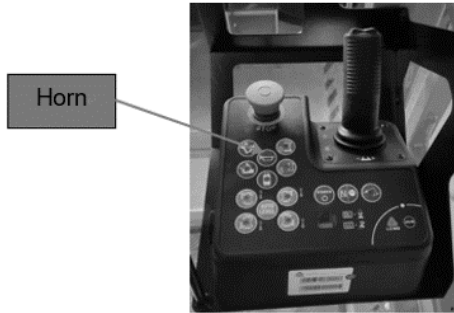

Fig. 4.4 Horn test

1. Start the engine and activate the platform control mode;
2. Press the horn button.

Control criteria: The horn sounds.

4.2.5 Drive and brake function test

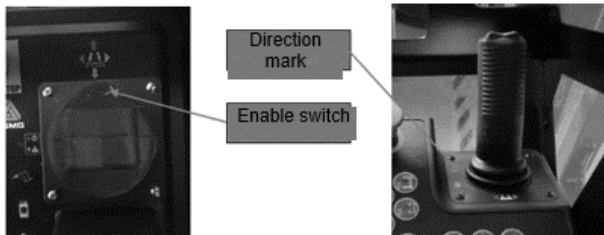

Fig. 4.5 Drive and brake function test

1. Press and hold the joystick function enable switch;
2. As indicated by the blue arrow on the control panel, slowly move the joystick until the machine under test starts to travel, and return the joystick to the center;

Control criteria: The machine under test travels as indicated by the blue arrow and stops immediately.

3. As indicated by the yellow arrow on the control panel, slowly move the joystick until the machine under test starts to travel, and return the joystick to the center;

Control criteria: The machine under test travels as indicated by the yellow arrow and stops immediately.

CAUTION: The machine under test shall be

able to stop steadily on any slope climbed by it.

4.3 No-load test

4.3.1 Outrigger leveling

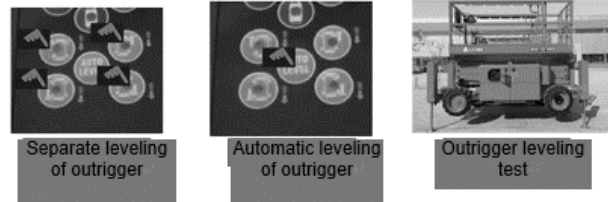

Fig. 4.6 Outrigger leveling

1. Outrigger test: Turn the key switch to PCU position, start the engine, press and hold the outrigger selector button, and meanwhile, move the joystick (forward to retract the outrigger and backward to extend the outrigger). After the outrigger is firmly on the ground, the button indicator is on.
2. Auto leveling: Turn the key switch to PCU position, start the engine, press and hold the AUTO LEVEL button, and meanwhile, move the joystick (forward to retract the outrigger and backward to extend the outrigger). After leveling, the 4 indicators on the outrigger buttons are on, and the PCU sounds the alarm.

Control criteria:

The outriggers are extended, the fork is lifted and lowered and the platform is extended smoothly, without abnormal noise;

4.3.2 Fork and platform

1. Test method:

After extending and leveling the outriggers, lift and lower the fork properly for 5 times respectively, and conduct normal start and stop for 2~3 times in the process; extend the platform twice, and conduct normal stop, fixation and start in the process;

Control criteria:

The outriggers are extended, the fork is lifted and lowered and the platform is extended smoothly, without abnormal noise.

4.4 Relief pressure test

4.4.1 System

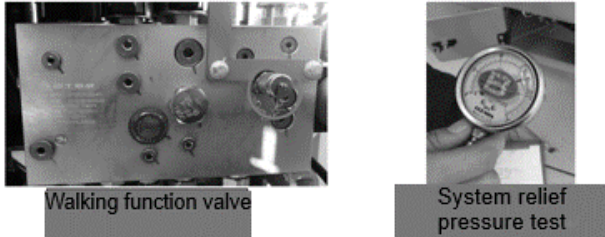

Fig. 4.7 System

1. Test the system pressure with the pressure tap supplied with the walking control valve;
2. Connect the pressure gauge to the pressure tap;
3. Couple the machine to the ground hook, build up the pressure during forward or backward running until the pressure gauge indicates the maximum value and maintain the pressure for 5 s. At this time, the indication of the gauge is the walking pressure. Record the pressure;

4.4.2 Lifting

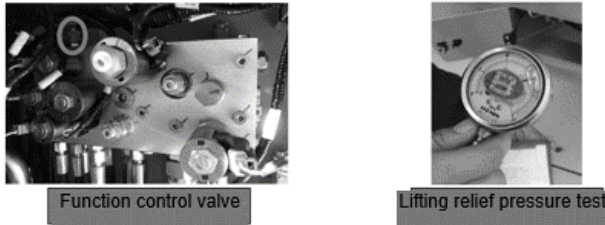

Fig. 4.8 Lifting

1. After measuring the system relief pressure, measure the lift relief pressure with the same pressure gauge;
2. Lift the machine to the limit height, observe the lift pressure until the pressure gauge indicates the maximum value, and maintain the pressure for 5 s. At this time, the indication of the gauge is the lift relief pressure. Record the pressure;
3. In case of inconsistency with the target value, do correction as follows:
Unscrew the fastening nut of the lift relief valve, and rotate the valve spool clockwise or counterclockwise with the Allen wrench to

increase or decrease the pressure as appropriate until the pressure is consistent with the target value;

Keep the position of the Allen wrench unchanged, and tighten the fastening nut of the lift relief valve; restore the rocker arm to the normal position.

4.4.3 Steering

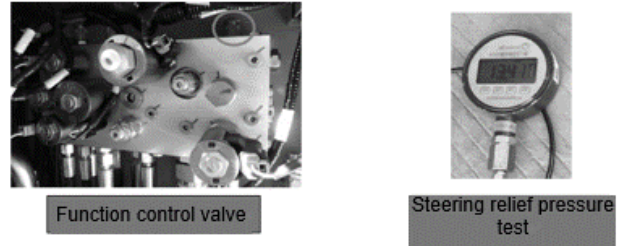

Fig. 4.9 Steering

1. Install the pressure tap at the illustrated position on the function control valve and connect it to the pressure gauge.
2. Turn the steered wheel to the left and right limit positions respectively, observe the steering pressure until the pressure gauge indicates the maximum value, and maintain the pressure for 5 s. At this time, the indication of the gauge is the steering relief pressure. Record the pressure;
3. In case of inconsistency with the target value, do correction as follows:
Unscrew the fastening nut of the system relief valve, and rotate the valve spool clockwise or counterclockwise with the Allen wrench to increase or decrease the pressure as appropriate until the pressure is consistent with the target value;
Keep the position of the Allen wrench unchanged, and tighten the fastening nut of the steering relief valve;

4.5 Calibration test

4.5.1 Inclination calibration



Parking on a horizontal platform

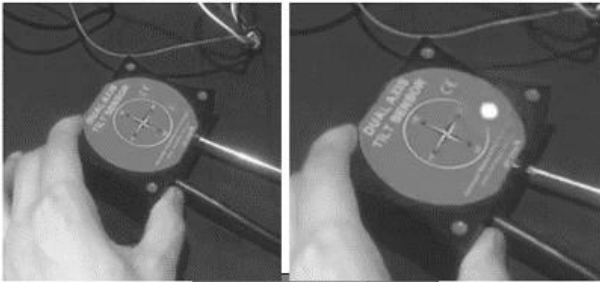

Adjustment

Fig. 4.10 Inclination calibration

1. Run the machine to the absolute level platform;
2. Adjustment method:
 - a. Park the machine on the absolute level platform;
 - b. Press and hold the inclination switch reset button for about 7 s until the green indicator flashes. Then release the reset button and tap it three times continuously. At that time, the indicator will flash and then stay on, indicating that the calibration of inclination switch is finished;

4.5.2 Outrigger leveling



Parking on a horizontal platform

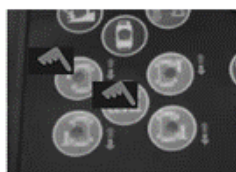

Automatic leveling of outrigger

Fig. 4.11 Outrigger leveling

1. After the inclination calibration, place the

machine on the absolute level platform again;

2. Adjustment method:

- 1) Press the emergency stop button of the platform control unit.
- 2) Press and hold "AUTOLEVEL" and the outrigger extend button at the upper left corner at the same time, as shown on the right.
- 3) Pull up the emergency stop button of the platform control unit until the buzzer sounds, indicating successful calibration.

4.5.3 Adjustment of level meter

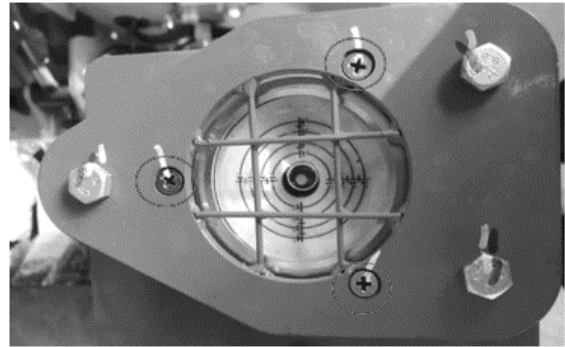

Fig. 4.12 Adjustment of level meter

1. After the outrigger leveling, place the machine on the absolute level platform again;

2. Adjustment method:

Adjust the three circled mounting points shown in the above Fig. with the Torx screwdriver and the open-end wrench to place the bubble of the level meter in the center, and then tighten the fixing nut.

Note: The tighter the nut, the higher the spring compression, and the closer the bubble will be to the screw.

4.6 Inclination test

4.6.1 Fore-and-aft 3°

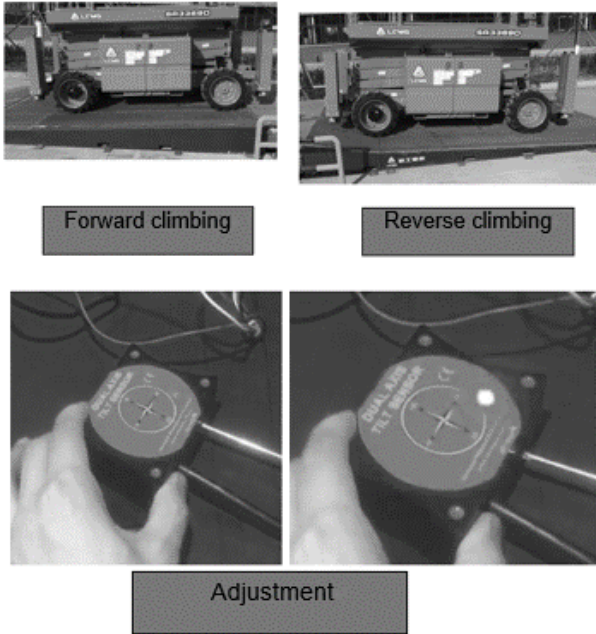

Fig. 4.13 Fore-and-aft 3°

1. Run the machine forwards and backwards to a 3° slope separately, ensuring the machine is completely on the slope;
2. Lift the fork, and test if the buzzer sounds. The inclination is conforming if the buzzer sounds; otherwise, the chassis inclination switch needs to be adjusted;
Refer to the calibration test (inclination calibration) for adjustment method.

Note:

After the adjustment of the inclination switch, both the fore-and-aft inclination and the left-and-right inclination need to be tested again;

4.6.2 Left-and-right 2°

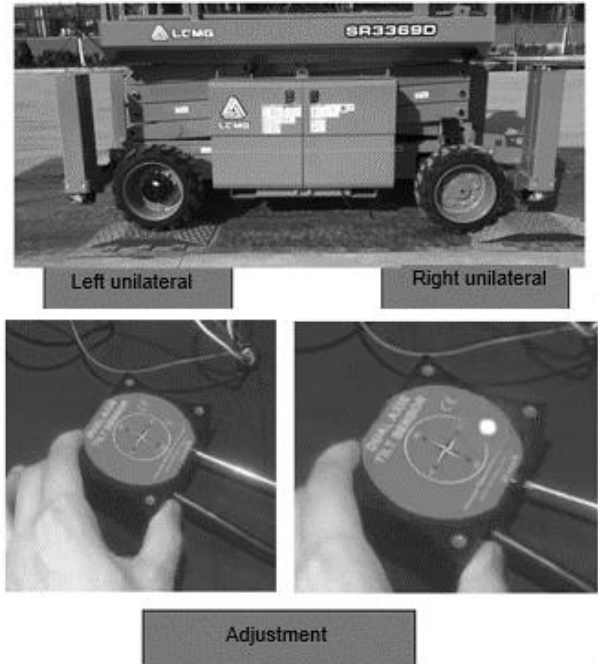

Fig. 4.14 Left-and-right 2°

1. Run the machine to move its left and right wheels to the “single-sided axle” separately, ensuring one wheel is completely on the axle and the other on the level ground;
Target left-and-right inclination: SR18D series: 2°;
2. Lift the fork, and test if the buzzer sounds. The inclination is conforming if the buzzer sounds; otherwise, the chassis inclination switch needs to be adjusted;
Refer to the calibration test (inclination calibration) for adjustment method.

Note:

After the adjustment of the inclination switch, both the fore-and-aft inclination and the left-and-right inclination need to be tested again;

4.7 Load calibration

4.7.1 Idle load

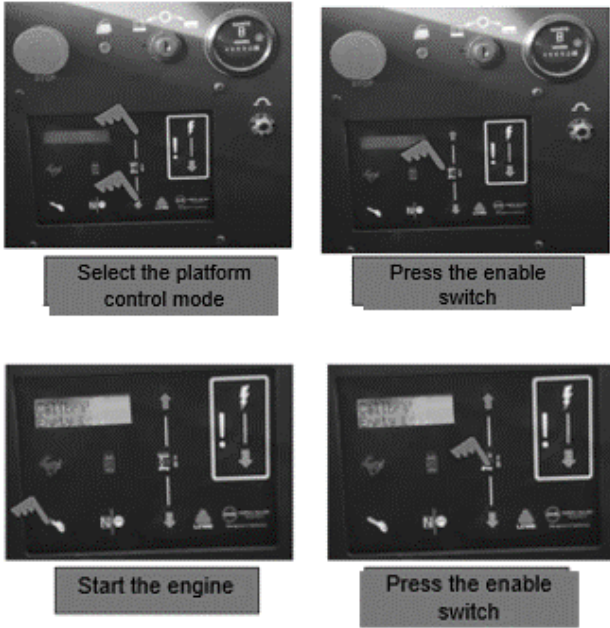
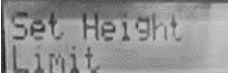
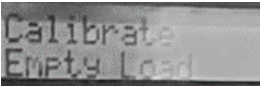
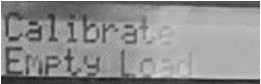

Fig. 4.15 Idle load calibration

1. Turn on the emergency stop switches of PCU and GCU, press UP and DOWN buttons with both hands simultaneously, and turn the key to the GCU position;
2. Press UP button until the display screen shows "Calibrate Mode", and then press the enable switch to enter  screen;
3. Press DOWN button until the display screen shows  ;
For purpose of calibration, the oil temperature should be 40°C. In case of low oil temperature, lift the fork several times to raise the oil temperature.
4. After entering  screen, press the ignition button to start the engine;
5. Press the enable switch to initiate idle load calibration of the machine.

4.7.2 Rated load

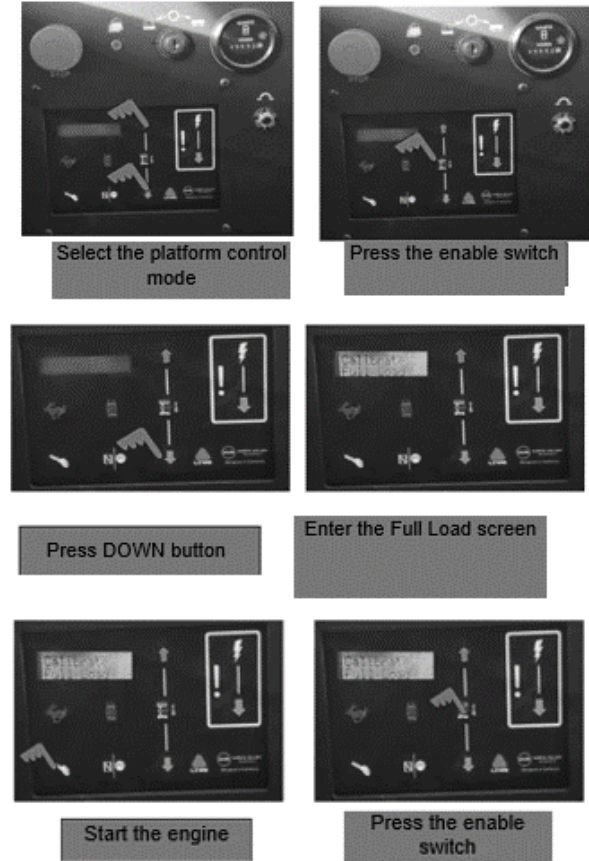
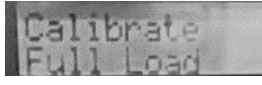

Fig. 4.16 Rated load calibration

1. Turn on the emergency stop switches of PCU and GCU, press UP and DOWN buttons with both hands simultaneously, and turn the key to the GCU position;
2. Press UP button until the display screen shows "Calibrate Mode", and then press the enable switch to enter the corresponding screen;
3. Press DOWN button until the display screen shows "complete".
For purpose of calibration, the oil temperature should be 50°C. In case of low oil temperature, lift the fork several times to raise the oil temperature.
4. After entering  screen, press the ignition button to start the engine;
5. Press the enable switch to initiate load calibration of the machine.

4.8 Overload function

4.8.1 Start

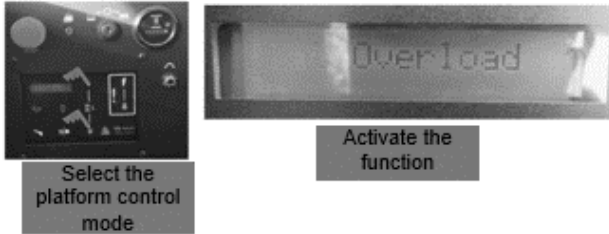

Fig. 4.17 Overload Start

1. After the full load calibration is completed, turn on the emergency stop switches of PCU and GCU, turn the key to the neutral position, press UP and DOWN buttons on the ground control panel, and meanwhile turn the key switch to GCU position to allow the system to enter the parameter setting mode,



2. Press UP or DOWN button until the LCD



screen shows . Afterwards, press the enable switch to enter Select Options screen, and press UP and DOWN buttons to adjust the options, and then press the enable switch to enter the PLAT OVERLOAD ON mode. Select ON mode



by operating the enable switch to enable the overload function.

4.8.2 Parameter setting

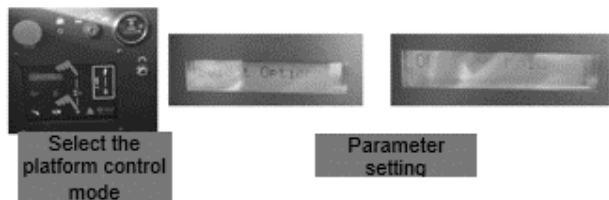

Fig. 4.18 Parameter setting

1. Turn on the emergency stop switches of PCU and GCU, turn the key to the neutral position, press UP and DOWN buttons on the ground control panel, and meanwhile turn the key switch to GCU position to allow the system to

enter the parameter setting mode;

2. Then press UP or DOWN button until the LCD display shows the corresponding information. Press the enable switch to enter Select Options screen, and press UP and DOWN buttons to adjust the options, and then press the enable switch to enter the OL Threshold mode.

Press UP and DOWN buttons to adjust the parameter value to meet the requirements that no alarm is sounded during lifting when the load reaches the rated value, and an alarm is sounded if the load reaches 1.2 times rated value. If the requirements are not met, adjustment should be made in time.

4.8.3 Test with 1.2 times rated load



Fig. 4.19 Test with 1.2 times rated load

No.	Model	Height for overload alarm
1	SR0818D	0.90m
2	SR1018D	1.00m
3	SR1218D	1.10m

Platform loading:

1. Drive the machine to the loading platform, making the machine platform flush with the loading platform;
2. Push the counterweight trolley to the machine platform and center it on the platform. Then set the safety hook of the trolley to the platform guardrail and apply the brake of the trolley;

Note: The gross weight of the counterweight trolley is 1.2 times the rated load;

Start the machine under test to carry out lifting:

Control criteria: neither lifting nor lowering can be achieved, and the load limiter works.

In case of overload alarm, the lifting height of the machine shall not exceed the required value.

After the overload alarm is triggered, the engine shall stop and can no longer be started again. In that case, emergency lowering should be carried out to reach the retraction state before restoration. After the overload alarm is triggered, the machine will be powered off and then powered on 3 min later. Then the alarm will continue sounding until overload recovery is achieved.

4.8.4 Overload recovery

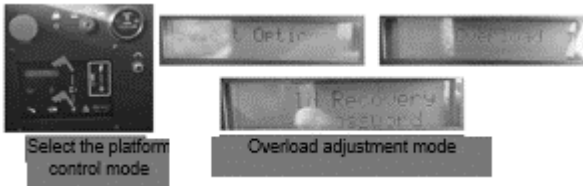

Fig. 4.20 Overload recovery

1. Turn on the emergency stop switches of PCU and GCU, turn the key to the neutral position, press UP and DOWN buttons on the ground control panel, and meanwhile turn the key switch to GCU position to allow the system to enter the machine setting mode;
2. Select the setting function to enter the setting screen, and operate UP and DOWN buttons to find the overload function option;
3. After the overload function screen is displayed, press and hold the lift switch for 5S until the password screen appears;
4. Press DOWN, DOWN, UP buttons and the lift switch in turn to eliminate overload until the screen displays overload clear, and in this case, return to the main menu, and complete overload information clearing.

4.8.5 Test with 1.25 times rated load

1. Turn off the weighing function;
2. Extend one side of the platform in place, fix the

platform and place the counterweight of 1.25 times rated load;

3. Lift and lower the test machine fully for 3 times respectively, and conduct normal start and stop for 2-3 times in the process. And conduct platform extension operation.
4. Place the platform counterweight on the extended platform on the other side, and conduct the test specified in step 1; and record the data properly.
5. Control criteria: There is no abnormal noise, jitter, impact, deformed or cracked structure during lifting and lowering; the platform extends smoothly without abnormal noise, and the hydraulic system does not leak;

4.9 No-load lifting time

4.9.1 No-load lifting time test

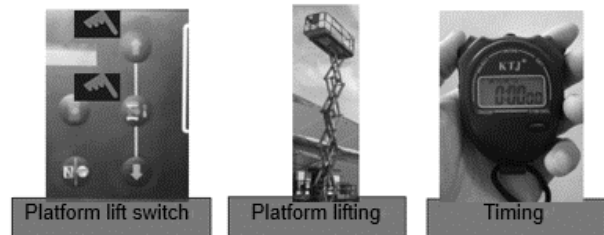

Fig. 4.21 No-load lifting time test

1. Lifting time: Move the machine under test to a flat ground, extend and level the platform outriggers, press the enable switch and UP button in ground control mode to lift the platform, and press the stopwatch switch to start timing. When the platform is lifted to the highest point, release the platform UP button, and press the stopwatch switch again to stop timing. The value displayed on the stopwatch is the lifting time; repeat the above steps twice;

Target lifting time for SR0818D model: 64±4(s);

Target lifting time for SR1018D model: 39±4(s);

Target lifting time for SR1218D model:

35±4(s);

- Lowering time: After measuring the lifting time, operate the machine reversely with the same method to measure the lowering time;

Target lowering time for SR1218D model:

55±4(s);

Target lowering time for SR1018D model:

46±4(s);

Target lowering time for SR1018D model:

30±4(s);

4.9.2 Adjustment of lifting speed

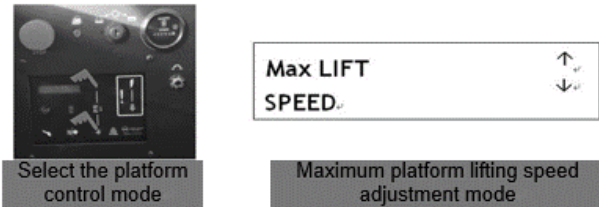

Fig. 4.22 Adjustment of lifting speed

- Shut down the machine, turn on the emergency stop switches of PCU and GCU, press and hold UP and DOWN buttons on the ground control panel simultaneously, and turn the key switch to GCU position. In this case, the parameter configuration mode of the system is activated, and the following content is shown on the display screen:



- Press the enable switch to activate the speed adjustment mode. After MAX FWD HIGHT SPEED DRIVE is shown on the display screen, press DOWN button. In this case, the display

screen shows



. Then press the enable switch to enter the corresponding screen;

- Enter the maximum platform lifting speed adjustment mode, press UP button to increase the drive speed and DOWN button to

decrease the drive speed;

- Press the enable switch to set the speed.

4.9.3 Adjustment of lowering speed

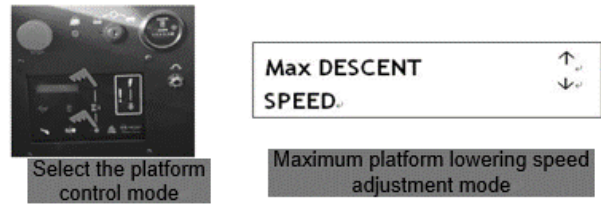

Fig. 4.23 Adjustment of lowering speed

- Shut down the machine, turn on the emergency stop switches of PCU and GCU, press and hold UP and DOWN buttons on the ground control panel simultaneously, and turn the key switch to GCU position. In this case, the parameter configuration mode of the system is activated, and the following content is shown on the display screen:



- Press the enable switch to activate the speed adjustment mode. After MAX FWD HIGHT SPEED DRIVE is shown on the display screen, press DOWN button. In this case, the display screen shows the corresponding content; press the enable switch to enter the corresponding screen;
- Enter the maximum platform lowering speed adjustment mode, press UP button to increase the drive speed and DOWN button to decrease the drive speed;
- Press the enable switch to set the speed.

4.10 Emergency lowering test

- For the ground controller**

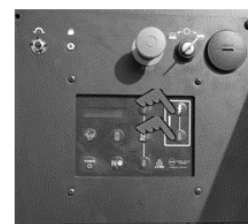

Fig. 4.24 Emergency lowering test

- After lifting the platform to the top

position, shut down the engine;

- 2) Turn on the emergency stop switch, turn the key switch to GCU position (without starting the engine), and press the buttons in the white box simultaneously by hands;

2. Use a pull line assembly

When the machine fails or other circumstances prevent the controller from being used for descent, the pull wire assembly equipped with the machine can be pulled outward to assist descent.

Control criteria: The platform descends from the top position to the lowest point, with the fork normal, and then the engine can be started normally.

4.11 Outrigger limit test (Idle load)

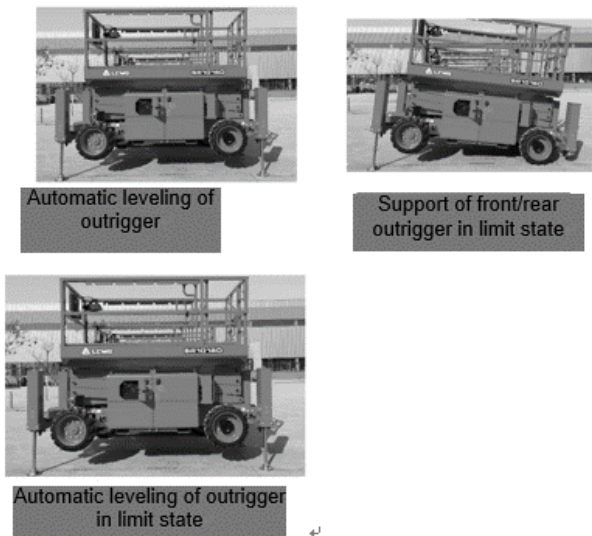

Fig. 4.25 Outrigger limit test (Idle load)

1. Drive the machine to a flat concrete ground, extend the outriggers, and perform automatic leveling;
2. Extend the two front or rear outriggers simultaneously to the limit state, and maintain this state for half a minute;
3. After the two front or rear outriggers are extended to the limit state, perform automatic leveling of the machine through PCU, and maintain this state for half a minute;

4. inspection criteria:

- 1) The oil circuit system of the outrigger is sealed properly, without oil leakage;
- 2) The fastening bolts of the outrigger are not loose, and the relevant parts of the outrigger such as the ball-head outrigger base are free of breakage, weld crack and other quality defects;

Note:

- 1) **Ensure that there is no person or machine within two meters around the machine during the test to ensure test safety, and that the test personnel wear seat belts;**
- 2) **This test should be carried out after the inclination calibration and the automatic leveling of the outriggers;**
- 3) **This test is a required inspection item.**

4.12 Floating test

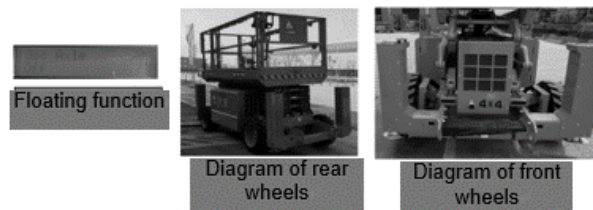

Fig. 4.26 Floating test

1. Check that the floating function option is activated in the GCU, and carry out the floating test, with the fork retracted and lifted respectively (lifted until the climbing indicator is on);
2. With the fork retracted, make the four wheels cross the pit with a depth of 0.1 m, during which one wheel falls into the pit while the others are placed on a flat ground;
3. Floating test criteria: The four wheels can touch the ground simultaneously after falling into the pit;
4. With the fork lifted, make the four wheels cross the pit with a depth of 0.1 m; the lifting height shall be such that the down limit switch can be

disengaged;

5. Floating test criteria: The machine cannot achieve floating function;

Note: During commissioning, the safety of the surrounding environment must be guaranteed, personnel must wear seat belts and other safety equipment; during the test in lifting state, the down limit switch must be disengaged, and the fork is strictly prohibited to be lifted too high;

4.13 Function test

4.13.1 Anti-pinch function

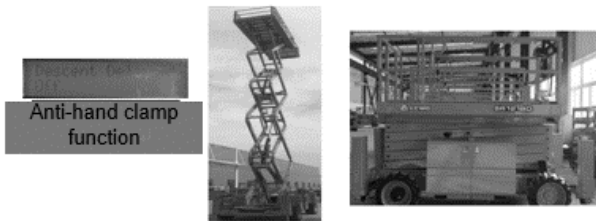

Fig. 4.27 Anti-pinch function

1. Access the function setting screen through the GCU, find the anti-pinch function option, and verify whether the function is activated ("On" for activation, "Off" for deactivation);
2. If the function is deactivated, activate it through the function button;
3. Verification method: Lift the fork of machine until the down limit switch is disengaged, and carry out lowering through the lowering function button;
4. Verification conclusion: After descending to the anti-pinch function position, the fork will be suspended, and the buzzer will sound faster. Once DOWN button is pressed again after being released, the buzzer will sound three times and then return to normal, and the fork will continue to descend.

Anti-pinch function position requirement: When the anti-pinch function is activated, the fork must not be in a fully retracted state, the remaining fork lowering travel should be about 5%~10%, and the remaining travel length should be about

0.8-1.6 m.

Note: During verification of the anti-pinch function, stop the machine before the anti-pinch function takes effect and verify that the fork will not drop automatically;

4.13.2 Beacon function

1. Access the function setting screen through the GCU, find the beacon and indicator function options, and verify whether the function is activated ("On" for activation, "Off" for deactivation);
2. If the function is deactivated, activate it through the function button;
3. Verification method: Switch on the machine power, and observe whether the indicator flashes normally; during operation of the machine, observe whether the indicator flashes normally;
4. Verification criteria: The beacon flashes in yellow at uniform frequency normally.

4.13.3 Operation alarm function

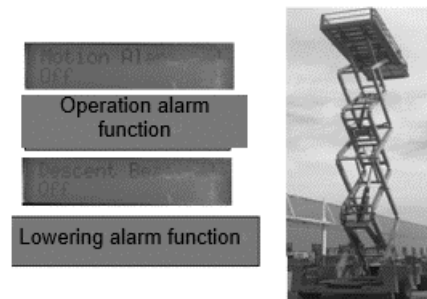

Fig. 4.28 Operation alarm function

1. Access the function setting screen through the GCU, find the operation alarm and lowering alarm function options, and verify whether the function is activated ("On" for activation, "Off" for deactivation);
2. If the function is deactivated, activate it through the function button;
3. Verification method: Start the machine, lift and lower the fork with the PCU and GCU, and drive the machine through the PCU;
4. Verification criteria: The buzzer of GCU

sounds during the operation of the machine.

4.13.4 Outrigger function



Fig. 4.29 Outrigger function

1. Access the function setting screen through the GCU, find the outrigger and outrigger inspection function options, and verify whether the function is activated ("On" for activation, "Off" for deactivation);
2. If the outrigger function is deactivated, activate it through the function button; if the outrigger inspection function is activated, deactivate it through the function button;
3. Verification method: Start the machine, and extend the outriggers with the PCU;
4. Verification criteria: After the outrigger is extended, the machine is automatically leveled and the outrigger indicator on the PCU stays on; after the outrigger is retracted, the outrigger indicator on the PCU goes out.

4.13.5 Overload function

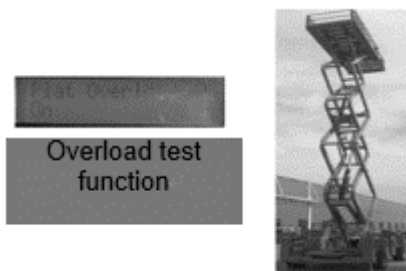

Fig. 4.30 Overload function

1. Access the function setting screen through the GCU, find the load inspection function option, and verify whether the function is activated ("On" for activation, "Off" for deactivation);
2. If the load inspection function is deactivated, activate it through the function button;
3. Verification method: Start the machine, and

verify whether overload alarm is given according to the overload verification procedure;

4. Verification criteria: Alarm will be given and lifting operation will be restricted after overload lifting.

4.13.6 Fuel level inspection function

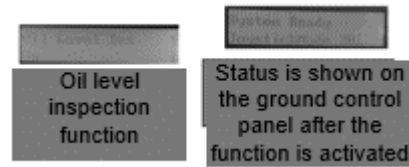

Fig. 4.31 Fuel level inspection function

1. Access the function setting screen through the GCU, find the fuel level inspection function option, and verify whether the function is activated ("On" for activation, "Off" for deactivation);
2. If the fuel level inspection function is deactivated, activate it through the function button;
3. Verification method: Power on the machine, and observe whether fuel level is displayed on the ground control panel, and whether low fuel level alarm is given by the GCU as fuel is consumed;
4. Verification criteria: Fuel level is displayed on the ground control panel and fuel alarm is given when the fuel level is below 22 L.

4.13.7 Lifting height for overload alarm

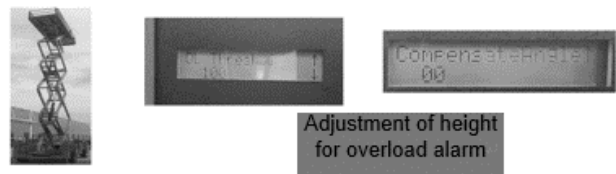

Fig. 4.32 Lifting height for overload alarm

1. Apply a load equal to 1.2 times the rated load to the platform, activate the overload function and lift the fork;
2. When the machine overload alarm is given, the lifting height of the fork shall not exceed 0.9m for SR0818D model, 1m for

SR1018D, and 1.1m for SR1218D;

3. If the limit value is exceeded, select "OL Threshold" and "Compensate Angle" on the function setting screen to increase the value until the alarm height requirement is met.

4.14 Basic operation

1. Basic operation principles

- 1) The electrical connections of the vehicle are well installed with a complete circuit formed, the sensor works normally, the main power supply is connected, and the start switch and emergency stop switch function normally.
- 2) When the start switch is turned on, the PCU or GCU is selected, and the emergency stop buttons on PCU and GCU are pulled up, no alarm and error code are activated.
- 3) The vehicle works normally, and the action of vehicle cannot be triggered unless the enable button and function selector button are pressed and the corresponding joystick is moved.

2. Operations on ground control unit (GCU)

- 1) Start or shutdown of engine
 - a) With the start switch in the Ground Control position, pull out the emergency stop switch, and then the GCU LCD displays "System Ready".
 - b) Press the engine start button, and about 3s after the engine starting sound is heard, release the engine start button, and then the vehicle starts.
 - c) To shut down the engine, press the emergency stop switch or turn the start switch back to the neutral position.
- 2) Platform lifting

Start the engine in the ground control mode, and after the system works normally, press the enable button and the lifting button at the same time to lift the platform; or press the

lifting function button and the lowering button at the same time to lower the platform.

3) Emergency lowering

When the platform fails to be lowered due to a fault, the emergency lowering function can be enabled, which is to lower the platform to the safe position by using the electric energy in the battery. To lower the platform in case of emergency, press the emergency lowering function enable button and the emergency lowering button at the same time.

3. Operations on platform control unit (PCU)

1) Start or shutdown of engine

- a) Turn the start switch to the Upper Control position, and then the PCU LCD displays "System Ready".
- b) Press the engine enable function button to start the engine and release it after 3 seconds.
- c) To shut down the engine, press the emergency stop switch.

2) Forward/backward travel

- a) After the system is initialized and the engine is started, check whether there are people, animals or other obstacles around the vehicle, and press the horn button to remind the people around that the vehicle is about to start.
- b) Press the travel function button, press the enable button on the PCU, and push the enable joystick forward or backward at the same time to make the vehicle travel forward or backward.
- c) When the enable switch on the joystick is released or the joystick is in the neutral position, the vehicle will stop moving.

3) Left/right turning

Press the enable button on the PCU and press the left turn or right turn button of the thumb rocker switch at the same time to make

the vehicle turn as desired; release the enable switch or the left turn/right turn button to stop turning.

4) Platform lifting/lowering

Turn the start switch to the upper control position, start the engine, press the lifting function button, press and hold the enable switch, and meanwhile, move the joystick in the direction of blue arrow to lift the platform, or move the joystick in the direction of yellow arrow to lower the platform.

5) Outrigger operation

Turn the start switch to the upper control position, start the engine, press and hold the outrigger function enable button of the corresponding outrigger (four outriggers in total), press and hold the enable switch, and meanwhile move the joystick in the direction of yellow arrow to extend the outrigger, or move the joystick in the direction of blue arrow to retract the outrigger. When the outrigger is landed on the ground firmly, the indicator light on the button will go on.

6) Automatic leveling

The vehicle needs to be leveled via outriggers when it is tilted, and the control system has the outrigger automatic leveling function. For the purpose of automatic leveling, turn the start switch to the upper control position, start the engine, press and hold the outrigger automatic leveling button, press and hold the enable switch, and meanwhile, push the joystick in the direction of yellow arrow or blue arrow to extend or retract the outrigger, and after the vehicle is leveled, the 4 indicator lights on the outrigger button will go on, and when you push the joystick at this time, an audible alarm will be given, and the outrigger cannot be extended, indicating that the vehicle has been leveled.

5 Maintenance

**Warning: Observing the regulations**

- **The operator can only check the regular maintenance items specified in this manual.**
- **As required by the manufacturer, the regular maintenance and inspection shall be performed by the trained maintenance technicians.**

5.1 Checking the safety manual

It is essential to keep the operation and safety manual in good condition to achieve safe operation of the equipment. The manual shall be stored in the file box in the work platform. If the manual is illegible or missing, the safety and operation information necessary for safe running cannot be provided.

1. Confirm that the container is provided on the site and kept in good condition.
2. Confirm that the operation, liability and safety manual is kept intact in the container on the work platform.
3. Check that every page of the manual is legible and intact.
4. Put the manual in the storage box after use.



To replace any manual, please

contact the service personnel of LGMG.

5.2 Checking the labels and signs

It is essential to keep all safety and description labels and signs in good condition to achieve safe operation of the equipment. Labels are used to remind the operation and maintenance personnel of potential hazards during operation of the equipment and provide operation and maintenance information for users. Illegible labels cannot remind the maintenance personnel of procedures or hazards and may also lead to unsafe operation.

Check whether all labels are in proper positions with reference to the label section in this manual and based on the label menu and description.

Check the legibility and condition of all labels, and replace the damaged or illegible labels promptly if any.



To replace the labels, please contact the service personnel of LGMG.

5.3 Checking for damaged, loose or missing parts

This procedure shall be implemented once every 8h or every day.

It is essential to check the equipment condition regularly to achieve safe operation and superior performance of the equipment. Incorrect positioning or maintenance and part damage, looseness or loss may lead to unsafe operation.

1. Check the equipment for damage, incorrect installation or part loss, including:
 - Electrical component, wire and cable
 - Hydraulic hose, connector, valve block and hydraulic cylinder
 - Fuel tank and hydraulic tank
 - Wear washer
 - Tire and wheel
 - Engine and its relevant parts
 - Limit switch and horn
 - Nut, bolt and other fasteners
 - Extended part of platform
 - Platform entrance
 - Indicator light and alarm
 - Safety arm
 - Scissor arm pin and fastener
 - Platform joystick
 - Outrigger cover and foot mat
- Inspect the entire machine to check:
- the welds or structural parts for cracks
 - the platform, fork and chassis for

deformation or sealing-off

- the machine for dent or damage
- that all structural parts and other key components are intact and all relevant fasteners and pins are installed in correct positions and tightened
- That the guardrail is mounted and its bolts are installed and tightened properly.

**CAUTION:**

If the platform needs to be lifted for inspection of the machine, make sure that the safety arm is kept in the correct position. Refer to “Operating instructions”.

5.4 Checking the GCU

This procedure shall be implemented once every 8h or every day.

It is essential to check the equipment function and red emergency stop button to achieve safe operation of the equipment. In the unsafe operation state or in case of any operation failure, the red emergency stop button will disable all equipment functions and shut down the engine. All functions shall be enabled, and the operation shall be performed stably, without any seizure, jitter or abnormal noise.

1. Pull up the red emergency stop buttons of GCU and PCU.
2. Turn the key switch to GCU position. Start the engine.
3. Do not press the lift switch. Try to turn on each function switch.

Result: All functions shall not be enabled.

4. Press and hold the lift switch, and turn on each function switch.

Result: All functions shall be enabled in a full cycle. When the platform descends, the buzzer shall be able to sound.

5. Push the red emergency stop button of GCU to “OFF”.

Result: The engine shall be shut down, and all functions shall not be enabled.

5.5 Checking the PCU

1. Turn the key switch to PCU position. Pull up the red emergency stop button on the ground control panel, and push it to “ON”.
2. Start the engine on the work platform.
3. Do not press the enable switch. Try to enable all functions of the equipment.

Result: All functions of equipment shall not be enabled.

4. Press and hold the enable switch. Try to enable all functions of the equipment.
- Result: All functions of the equipment shall be enabled in a full cycle.

5. Push the red emergency stop button of PCU to “OFF”.

Result: The engine shall be shut down, and all functions of the equipment shall not be enabled.

5.6 Checking the wires

This inspection shall be performed once every 8h or every day whichever comes first.

1. It is essential to keep the wires in good condition to achieve safe operation and superior performance of the machine. Failure to find and replace the burned, scratched, corroded or bent wires will lead to an unsafe operating environment, causing damage to the machine parts.

**Risk of electric shock/explosion**

Thermal contact or live conductors may cause serious personal injury or death. Do not wear rings, watches or other ornaments.

2. Check if the ground wire under the chassis is missing or damaged.
3. Check for burnt, scratched, corroded, bent or loose wires in the followings areas:

- GCU box
 - Hydraulic valve group
 - Battery wire
 - PCU box
5. Turn the key switch to PCU position, and pull up the red emergency stop buttons of GCU and PCU.
 6. Lift the platform to a height of 4m above the ground.
 7. Lift the safety arm, move it to the middle of the scissor bushing, and rotate it upward until it is vertical.
 8. Lower the platform until the safety arm is in full contact with the bushing.



Risk of crushing

When lowering the platform, be sure to keep the hands in the correct position of the safety arm.

9. Check for burnt, scratched, corroded, bent or loose wires in the chassis and scissor areas.
10. Check for burnt, scratched, corroded, bent or loose wires in the following areas:
 - Scissor arm
 - Part between the ECU and the platform
 - Connector of the harness connected to the platform
11. Check the free coating of insulating oil applied to the following parts:
 - Connector of the harness between ECU and PCU
 - Connectors of all harnesses of the level sensor
12. Lift the platform and return the safety arm to the installation position.
13. After lowering the platform to the retraction position, shut down the machine

5.7 Checking the battery

Stay away from the fireworks, and remove all rings, watches and other ornaments. Wear

goggles, protective gloves and protective clothes if necessary. Avoid touching the spilled electrolyte with hands or other parts of the body. Use soda and water to neutralize the spilled electrolyte.

It is essential to keep the battery in good condition to achieve superior machine performance and safe operation. If the voltage is improper or the cable or wire is damaged, the parts may be damaged and hazards may be caused.

Inspection of maintenance-free lead-acid battery:

- Check if the battery lock lever is stable.
- Check if the battery cable is connected firmly, without corrosion.
- Check if the electrolyte leaks, and if the battery is dry and clean.

Check the electric eye status quarterly (for maintenance-free lead-acid battery).

Check the color of the battery hydrometer as shown:



Fig. 5.1 Battery hydrometer

Hydrometer color	Meaning and measures
White	Lack of electrolyte; please shut down the machine to stop using it
Black	Undervoltage or damage
Green	Measure the voltage of each battery, and if the voltage is lower than 11V, it means the battery is damaged; if the voltage is between 12.4V-12.7, it means the battery is in good condition

- If the color of the battery hydrometer is green and the voltage is above 12V, but the starter cannot be driven, the trained and qualified maintenance personnel shall conduct further inspection of the battery.

Battery charging:

- Before charging, disconnect the battery negative wire and then the battery positive wire.
- Before charging, clean the terminals and remove the scale on the surface.

**CAUTION:**

If an external power supply is required to charge the battery, only the charger approved by LGMG can be used.

The battery with white electric eye may not be charged, but be replaced.

After charging, connect the positive wire and then the negative wire.

**CAUTION:**

It is necessary to add the terminal protector and corrosion-resistant sealant to protect the battery terminals and cables against corrosion.

5.8 Checking the tires and wheel hubs

This inspection shall be performed once every 50h or every half month whichever comes first.

It is essential to keep the tires and wheel hubs in good condition to achieve safe operation and superior performance of the machine. Any failure of the tires and wheel hubs may cause rollover of the machine. If the failure isn't found or eliminated in time, the machine parts will be damaged.

1. Check the tire tread and side for scratch, crack, puncture and other abnormal wear.
2. Check the wheel hub for damage, bending and crack.
3. Check whether the tire process screw falls off. After falling-off of the screw, if a few fillers or no fillers leak out and the tire body is free of significant deformation, the user

can drive a screw in a size slightly larger than the vent diameter by about 5mm/0.20in using a hammer; if a lot of fillers leak out and the tire body is deformed significantly, it is necessary to lower the work platform and replace the tire in time.

4. Tightening torque of wheel nuts: 305 ± 25 N.m.

5.9 Checking the hydraulic tank vent cap

1. This inspection shall be performed once every 8h or every day whichever comes first.
2. It is essential to keep the hydraulic tank vent cap ventilated to achieve superior mechanical performance and long service life. If the vent cap is dirty or clogged, the performance of the machine may be deteriorated. The vent cap shall be checked frequently in a harsh working environment.
 - a. Remove the hydraulic tank vent cap.
 - b. Perform the inspection through ventilation.

Result: Air can pass through the vent cap.

Result: If air cannot pass through the vent cap, clean or replace the vent cap. Continue to implement step 3.

NOTE: When checking the ventilation of the hydraulic tank vent cap, air shall be able to pass through the vent cap freely.

- c. Carefully clean the hydraulic tank vent cap with mild solvent and dry it with low-pressure compressed air. Repeat step 2.
3. Install the hydraulic tank vent cap.

5.10 Checking for leakage of hydraulic oil

The leakage shall be checked once every 8h or every day.

**Risk of personal injury.**

Splashed hydraulic oil will penetrate and burn the skin.

1. Check for hydraulic oil sediments, droplets or residues in the following areas.
 - All hydraulic cylinders.
 - Spools
 - All oil pipes and joints
 - Walking motor
 - Reducer
 - Filter
 - Hydraulic tank
 - Hydraulic pump
 - Area under the chassis
 - Shaft
 - Ground under the equipment.

5.11 Checking the hydraulic filter

The hydraulic filter shall be checked or replaced once every 550h or every six months.

**Note:**

In a dusty working environment, it is required to increase the number of times for implementation of this step.

It is essential to replace the hydraulic filter to achieve superior performance and long service life of the machine. If the filter is dirty or clogged, the performance of the machine may be deteriorated, and the parts may be damaged after continuous use. In an extremely dirty working environment, it is required to increase the number of times for replacement of the filter.

**Risk of personal injury.**

Be careful of hot oil. The contact with hot oil will cause severe burns.

**Note:**

This step shall be implemented when the

engine is shut down.

Replacement of the return filter element of the hydraulic tank:

1. Implement this step once every 550h or every six months whichever comes first.
2. It is essential to replace the return filter element to achieve superior performance and long service life of the machine. If the filter is dirty or clogged, the performance of the machine may be affected, and the parts may be damaged after continuous use. The filter element shall be replaced frequently in a harsh working environment.

**CAUTION: Risk of burns.**

Be careful of hot oil. The contact with hot oil may cause severe burns.

- ① Open the upper cover of the hydraulic tank.
- ② Remove the upper filter element flange of the hydraulic tank.
- ③ Pull out the filter element and replace it with a new one.
- ④ Install the flange and cover.
- ⑤ Use a marker to write down the replacement time and date on the filter element replacement record.
- ⑥ Turn the key switch to GCU position, and pull up the red emergency stop buttons of GCU and PCU.
- ⑦ Press the lift switch.
- ⑧ Check the filter components for oil leakage.

Replacement of the high pressure filter element

1. Place a suitable container under the filter.
2. Remove the nut at the bottom of the filter cover with a wrench, and remove the filter cover.
3. Take out the filter element from the filter cover.

4. Check the seal of the filter cover, and replace it when necessary.
5. Install a new high pressure filter element, and tighten it.
6. Wipe off any oil droplets splashed during installation.
7. Check that the filter cover and relevant components are free of leakage.

5.12 Replacing the air filter of the hydraulic tank

The air filter of the hydraulic tank shall be replaced once every 500h or every day. In a dusty working environment, it is required to increase the number of times for implementation of this step.



Note:

This step shall be implemented when the engine is shut down.

1. Remove the filter element.
2. Wipe the internal part and rear cover of the cartridge with a piece of wet cloth.
3. Install a new air filter element.

5.13 Checking the hydraulic oil level

This inspection shall be performed once every 8h or every day.

It is essential to keep a proper hydraulic oil level to ensure normal working of the machine. If the hydraulic oil is at an improper level, the hydraulic components will be damaged. Through a daily inspection, the inspector can determine the hydraulic oil level change which indicates that the hydraulic system is faulty.



CAUTION:

This procedure shall be implemented when the platform is retracted and the engine is shut down.

1. Stop the machine on a flat ground. Retract the platform.
2. Check the oil level sight glass on the hydraulic tank. When the fork is retracted, the hydraulic oil level shall be at 1/2~2/3 (for short level gauge) or "LH" scale (for long level gauge) of the level gauge.

5.14 Checking or changing the hydraulic oil

Change hydraulic oil and replace the suction filter

Every 2,000 h or two years, whichever comes first.

Before changing the hydraulic oil, check the hydraulic oil to verify if it is necessary to change the oil. If the hydraulic oil isn't changed during inspection in 2,000 h, it shall be checked on a quarterly basis. Change the hydraulic oil if it does not pass the inspection.



CAUTION:

The hydraulic oil suction filter should be replaced during change of the hydraulic oil.

Park the machine on a level ground, and put it in retracted position.

1. Close the ball valves on the hydraulic tank.



Risk of part damage.

Do not start the engine when the ball valves of the hydraulic tank are closed; otherwise the parts will be damaged. If the ball valves are closed, it is required to remove the key from the key switch and hang a warning sign on the equipment.



Risk of personal injury.

Splashed hot oil can penetrate and burn the skin.

2. Remove the oil drain plug from the hydraulic tank.

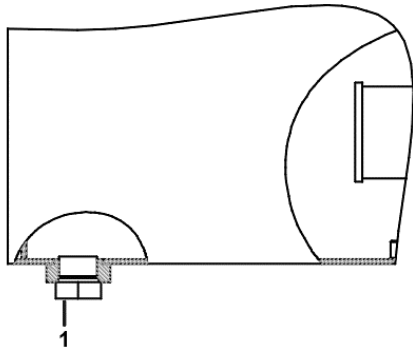

Fig. 5.2 Oil drain plug

1. Oil drain plug

3. Drain the hydraulic oil from the hydraulic tank completely into a suitable container. To increase the drain speed, open the tank filler cap.
4. Remove the ring magnet and oil drain flange.
5. Remove the suction filter from the hydraulic tank.

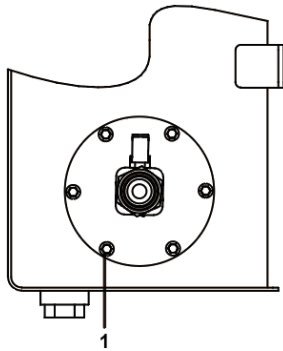



Fig. 5.3 Oil suction flange

1. Oil suction flange bolt

6. Flush the inside of the hydraulic tank with a mild solvent. (Clean it with chemical cleaning agent at first. After drying, flush with clean hydraulic oil and drain the oil.)
7. Remove the foreign objects adsorbed by the ring magnet.
8. Install a new suction filter.
9. Install the oil drain plug, ring magnet and oil drain flange.
10. Add the hydraulic oil to the hydraulic tank until the oil level reaches 1/2~2/3 (for short level gauge) or "LH" (for long level gauge) scale of

the level gauge. Ensure that the hydraulic oil doesn't overflow.

11. Remove the possibly splashed hydraulic oil.
12. Open the ball valves on the hydraulic tank.

 **Risk of part damage.**

After installing the hydraulic tank, be sure to open the ball valves of the hydraulic tank and inject oil to the pump.

 **CAUTION:**

When installing the filter, be sure to apply pipe thread sealant.

13. Check all functions of the machine in a full cycle, and check for oil leakage.
14. After a working cycle is finished, recheck the oil level of the hydraulic tank, and add oil until it reaches 1/2~2/3 (for short level gauge) or "LH" (for long level gauge) scale of the level gauge.

5.15 Checking the oil level of the reducer

This procedure shall be implemented every 250h.

If the oil level of the reducer is incorrect, the performance of the machine will be deteriorated, and the parts will be damaged after continuous use.

1. Drive the equipment to rotate until one filler plug is at the highest point and the other is horizontal.
2. Remove the horizontal plug and check the oil level.

Result: The oil level should be at the lower edge of the horizontal plug.

3. When necessary, remove the upper filler plug, and add oil until the oil level is flush with the bottom of the side plug hole.
4. Apply the pipe thread sealant to the plug, and install the plug into the reducer.

5. Repeat this step for each reducer.

5.16 Changing the reducer gear oil

The first maintenance shall be performed upon operation for 50h, thereafter reducer gear oil shall be changed every 1000h or every year.

It is essential to change the reducer gear oil to achieve superior performance and long service life of the equipment. If the reducer gear oil isn't changed every year, the performance of the equipment may be deteriorated, and the parts may be damaged after continuous use.

1. Select the reducer to be maintained and drive the equipment until one of the two filler plugs is at the lowest point.
2. Remove the two filler plugs, drain the oil (completely), and collect it in a suitable container.
3. Drive the equipment to rotate until one oil filler is at the highest point.
4. Add oil from the hole of the reducer at the high point until the oil level is flush with the side hole at the bottom. Install the plug.
5. Repeat this step to add oil to each reducer.

30°C < Minimum temperature	85W/140
-10°C < Minimum temperature < 30°C	85W/90
-30°C < Minimum temperature < -10°C	80W/90
Minimum temperature < -30°C	75W

5.17 Checking the cooling system

Checking the coolant level

The coolant level shall be checked every 10h.

The coolant level shall be between MAX and MIN of the expansion tank.

Changing the coolant

The coolant shall be changed once every 2000h or every two years whichever comes first.

 **CAUTION risk of machine damage.**

If the coolant beyond the specified interval is used, the cooling system will be clogged and the engine will be damaged. The coolant shall be changed at the specified interval.

Draining the coolant

1. Shut down the engine and cool it down.
2. Remove the coolant filler cap from the radiator.
3. The coolant drain point is under the radiator.
4. Put the hose in a suitable container.

5.18 Maintenance of Kubota engine

5.18.1 Checking the engine oil level

 **No working on a running engine!**

 **No smoking or open flames!**

 **Be careful when handling high temperature engine oil. Risk of burns!**

 **Caution:**

When working on the oil system, pay attention to the cleanliness of the outer surface. Carefully clean all areas involved. Dry the wet parts with compressed air.

 **Caution:**

Please abide by the oil safety provisions and local regulations. Dispose of spilled oil and filter elements as specified. Ensure that waste oil doesn't drip to the ground.

 **Caution:**

Perform a trial run after each operation. Meanwhile, pay attention to the tightness and lubricating oil pressure, and check the engine oil level once every 8h or every day.

Insufficient or excessive oil will cause engine damage. The oil level can be checked only when the engine is placed horizontally and shut down. If

the engine is hot, shut it down, and after 5 minutes, check the oil level. If the engine is cold, check the oil level immediately.

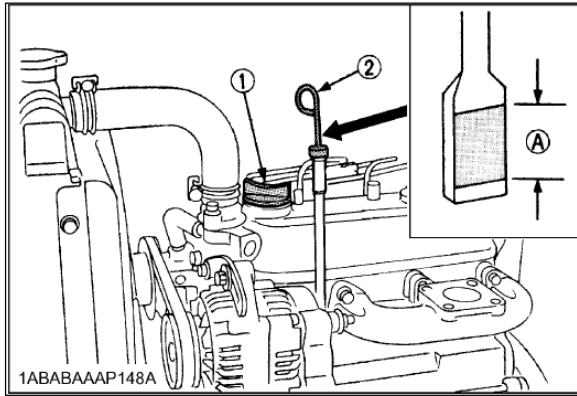

Fig. 5.4 Engine oil level

1. Oil dipstick 2. Oil filler plug

1. Insert the oil dipstick, and wipe it with a piece of clean fiber-free cloth.
2. Insert the oil dipstick to the end.
3. Pull out the oil dipstick, and read the oil level.
4. Ensure that the oil level is always between MIN and MAX!

Add the engine oil until it reaches the MAX mark if necessary.

5.18.2 Changing engine oil and replacing oil filter

 **No working on a running engine!**

 **No smoking or open flames!**

 **Be careful when handling high temperature engine oil. Risk of burns!**

 **Caution:**

When working on the oil system, pay attention to the cleanliness of the outer surface. Carefully clean all areas involved. Dry the wet parts with compressed air.

 **Caution:**

Please abide by the oil safety provisions

and local regulations. Dispose of spilled oil and filter elements as specified. Ensure that waste oil doesn't drip to the ground.

 **Caution:**

Perform a trial run after each operation. Meanwhile, pay attention to the tightness and lubricating oil pressure, and check the engine oil level once

Engine oil shall be changed and oil filter replaced at first 50 hours and then every 250 hours. (If the ambient temperature is consistently below -10°C (14°F), the oil temperature is below 60°C (84°F), or the sulfur content in diesel is within 0.5-1%, the oil change cycle shall be halved; if the oil does not reach the change cycle in one year, the oil shall be changed at least once a year.)

 **Risk of burns.**

Be careful of high temperature engine parts and oil. Getting into contact with high temperature engine oil and/or engine parts can cause serious burns.

 **Caution:**

Perform this function after the engine warms up to normal operating temperature.

1. **Changing engine oil:**

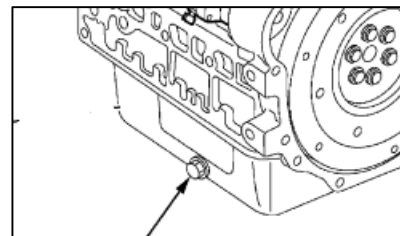

Fig. 5.5 Oil drain plug

- 1) Warm up the engine (oil temperature > 80°C).
- 2) Place the engine horizontally.
- 3) Shut down the engine.
- 4) Place a container under the oil drain plug.

- 5) Unscrew the oil drain plug to drain the old oil.
- 6) Install a new seal ring on the oil drain plug, screw the oil drain plug in and tighten it.
- 7) Add oil at the oil filler.
- 8) Warm up the engine (oil temperature > 80°C).
- 9) Place the engine horizontally.
- 10) After the oil is added, wait for more than 5 minutes, check the oil level, and add oil if necessary.

Operating ambient temperature	Hydraulic oil type
-20°C~40°C	15W-40
-25°C~30°C	10W-30
-30°C~30°C	5W-30
-35°C~20°C	0W-20

2. Replacing the oil filter

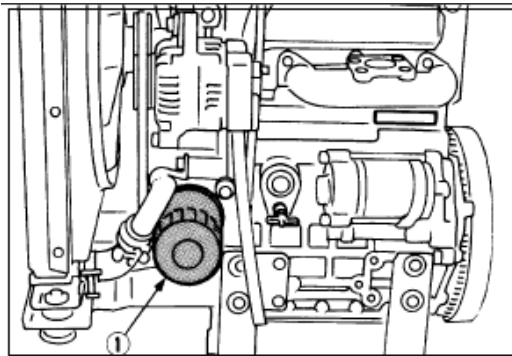

Fig. 5.6 Engine oil filter

1. Engine oil filter

Every time the oil is changed, the oil filter element shall be replaced.

⚠ Never pre-install the oil filter. There is a risk of contamination.

1. Loosen and unscrew the filter element using a wrench.
2. Collect the discharged engine oil.
3. Clean the sealing surface of the filter bracket with a clean fiber-free cloth.
4. Apply a thin layer of oil to the seal ring of the new filter.
5. Screw the new filter by hand until it is sealed, and then screw it 3/4 times with the

wrench of the filter element after manual tightening. do not screw it too tight to avoid oil leakage.

5.18.3 Checking fuel leaks



Engine must be shut down!

No smoking or open flames!

Be careful when handling hot fuel!

Please observe safety regulations on fuel and relevant local laws and regulations.

Dispose of spilled fuel and filter elements according to national regulations. Fuel must not leak to the ground.

Visually check whether there is fuel leakage every 8 hours or everyday.



Risk of explosion and fire.

Fuel is combustible. Check the location of the machine. This step shall be performed in open and well-ventilated areas away from heaters, sparks, flames, and burning tobacco. A conforming fire extinguisher should be placed in an easily accessible place.



Risk of explosion and fire.

If a fuel leak is found, irrelevant personnel shall be prevented from entering the area and operation on the equipment is prohibited. The leak shall be repaired immediately.

5.18.4 Cleaning or replacing the fuel filter



Engine must be shut down!

No smoking or open flames!

Be careful when handling hot fuel!



Caution:

Do not loosen the fuel injection pipeline or high pressure fuel pipeline while the engine is running.



Caution:

Carefully clean all areas involved. Dry the wet parts with compressed air.



Caution:

Please abide by the fuel safety provisions and local regulations. Dispose of spilled fuel and filter elements according to national regulations. Fuel must not leak to the ground.



Caution:

After the operation on the fuel system is completed, bleed the system, conduct a trial run and check the tightness.

Cleaning the fuel filter element

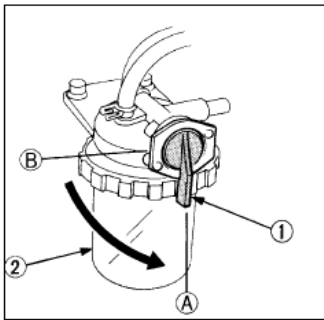

Fig. 5.7 fuel filter

- 1. Fuel filter handle 2. Fuel filter (water separator)
- A "On" ,B "Off"

1. Clean the fuel filter at a clean place every 100 hours to avoid entry of dust.
2. Turn off the fuel filter handle.
3. Remove the top cover and then clean the inside with diesel.
4. Take out the filter element and clean it with diesel.
5. Coating the seal ring of the new filter with diesel oil;
6. Reinstall the filter element;
7. Bleed the fuel system.

Replacing the fuel filter element:

1. Replace the filter every 400 h, or more

frequent in case of extremely dirty working environment.

2. Apply a thin layer of fuel to the gasket and tighten the strainer in place by hand.
3. Finally, discharge the air.

5.18.5 Bleeding the fuel system

Checking air filter maintenance indicator every 8 hours or daily (ifequipped).



Perform this step while the engine is shut down.

Checking the maintenance indicator of the air filter. When the transparent part of the indicator appears red, the filter element of the air filter needs to be replaced.

5.18.6 Cleaning or replacing the air cleaner



No working on a running engine!



Caution:

When working on the engine intake system, pay attention to the cleanliness of the outer surface, and close the intake port if necessary. Dispose of old cleaner elements in an environmentally friendly manner.

Cleaning the air cleaner

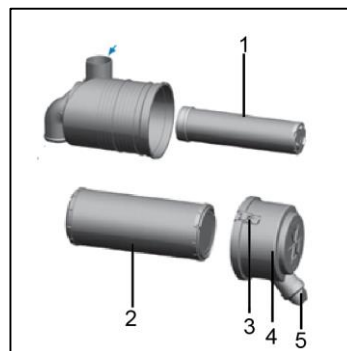

Fig. 5.8 the air cleaner

- 1. Inner element 2. Outer element 3. Positioning plate 4. End cover 5. Dust valve

1. Open the positioning plate (3).
2. Take off the filter cover (4) and unscrew the outer element (2).
3. Clean the outer element (2): In case of slight contamination, tap the end surface or purge the air cleaner from inside towards outside with dry compressed air for cleaning (generally not more than 5 times of cleaning); replace the cleaner element when it is seriously contaminated.

Note:The compressed air pressure is 0.2-0.3Mpa/29-43.5mph , up to 0.5Mpa/72.5mph, otherwise,the filter element will be damaged.

Replacing the air cleaner inner element



Caution:

Never clean the inner element (1). The outer element and the inner element shall be replaced together.

1. Unscrew the inner filter (1). Install a new inner element.
2. Screw in the new outer element (2), gently press the outer edge surface, install the cover (4) and fix it with the positioning plate (3).

5.18.7 Checking the coolant level

Check the coolant level every 8 hours or everyday.



High temperature coolant can cause burns.

The cooling system is under pressure! The cover can only be opened when it is cooled.

Coolant must have the protectant concentration specified for the cooling system!

Please observe safety regulations on coolant and relevant local laws and regulations.

Dispose of spilled coolant according to regulations and do not spill it on the ground.

Never run the engine without coolant, even

for a very short time.

1. Carefully open the cover of the cooling system.
2. The coolant level should always be between the Min. and Max. marks! Add the engine oil until it reaches the MAX mark if necessary.

5.18.8 Adding or changing engine coolant

Change the engine coolant every 2000 hours or every two years.



High temperature coolant can cause burns.

The cooling system is under pressure! The cover can only be opened when it is cooled.

Coolant must have the protectant concentration specified for the cooling system!

Please observe safety regulations on coolant and relevant local laws and regulations.

Dispose of spilled coolant according to regulations and do not spill it on the ground.

Never run the engine without coolant, even for a very short time.

Draining the cooling system

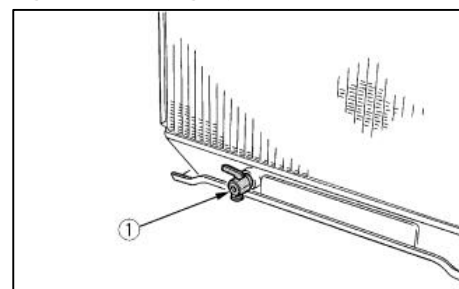

Fig. 5.9 Drain plug

1. Carefully open the cooler cover.
2. Position the container under the coolant port.
3. Drain the coolant.
4. Reconnect and tighten the coolant port.
5. Close the cooler cover.

Adding coolant:

1. Carefully open the cover of the cooling system.

2. Add the coolant to the Max. mark or to the limit position.
3. Turn on the possible heater and adjust it to the maximum, so as to fill the heater circuit and bleed it.
4. Close the cooler cover.
5. When the engine is still hot, start it to the operating temperature.
6. Shut down the engine.
7. Check the coolant level when the engine cools down, and add coolant to the Max. mark if necessary.



CAUTION:

Coolants with different freezing points should be selected according to the local ambient temperature. In principle, the freezing point of the coolant should be 10°C - 15°C lower than the local minimum ambient temperature.

If the coolant reduces rapidly:

1. Check whether there is dust and dirt between the radiator fins and the radiator tubes.
2. Check the fan belt tension.
3. Check the radiator water pipe for scale.

5.18.9 Checking the engine belt

Check the belt every 8h or everyday.



Caution:

Work on the pulley only when the engine is at rest.



Risk of burns.

Be careful of high temperature engine parts. Getting into contact with high temperature engine parts may cause serious burns.

1. Visually check all pulleys for damage.
2. Replace the damaged components.
3. Reinstall the protective device if necessary.
4. When it is a new belt, pay attention to whether its position is correct. After running for 15 minutes, check the tension.

Adjusting the fan belt tension

1. Shut down the engine.
2. Apply appropriate pressure to the belt between the pulleys with your thumb
3. If the tension is not correct, loosen the alternator mounting bolts and pull the alternator out with the lever between the alternator and the engine block until the belt deflection is within the permissible limit.

Proper fan belt tension	The belt deflection should be 7-9 mm/ 0.28-0.35in when the middle part of the belt span is pressed.
-------------------------	---

Checking the belt

5.19 Engine DTCs

Fault diagnosis of Kubota engine

1. It is difficult to start the engine

Fault cause	Action
Thick fuel hard to flow	Check the fuel tank and fuel filter. Remove water, dust and other impurities. Because all fuel will be filtered by the fuel filter, if there is water or other foreign matter in the fuel filter, please clean the fuel filter with kerosene.
Air or water mixed in the fuel system	If there is air in the fuel filter or fuel injection line, the fuel pump will not work properly. To obtain the correct fuel injection pressure, check the machine carefully for loose fuel pipe fittings, locking nuts, etc. Remove all air from the fuel system by loosening the connecting bolts of the fuel injection pump and immobilizing the fuel filter and the vent cock.
Incorrect valve clearance	When the engine cools down, adjust the valve clearance.
Valve leakage	Grind the valve.
Fuel injection timing error	Check the fuel injection timing.
Thickened lubricating oil of the machine in cold weather, resulting slow engine start	Change the oil grade according to the weather (temperature).
Insufficient compression	The valve is in poor condition or the ring, piston and bushing are excessively worn, leading to insufficient compression. Replace them with new ones.
Depleted battery, resulting in engine unable to start	Charge the battery. In winter, remove the battery from the machine, fully charge it and store it indoors. When the battery is needed, install it on the machine.

2. Output is insufficient

Fault cause	Action
Insufficient compression Valve leaks.	The valve is in poor condition or the ring, piston and bushing are excessively worn, leading to insufficient compression. Replace them with new ones. Grind the valve.
Insufficient fuel	Check the fuel system.
Moving parts overheat.	Check the lubricating oil system. Check whether the lubricating oil filter works properly. Filter element with deposited impurities will cause poor lubrication. Replace the filter element. Check whether the clearance of bearings is within the factory specifications. Check the fuel injection timing. Adjust the timing.
Incorrect valve clearance	When the engine cools down, adjust the valve clearance appropriately.
Dirty air cleaner	Clean the filter element once every 100 hours of operation.
Wrong fuel injection pressure	Check the injection pressure.
Worn injection pump	Do not use inferior fuel, because it will cause wear of the pump. Please use No. 2-D diesel only. (Refer to "Fuel" in "Scheduled maintenance".)

	Check the fuel injection pump filter element and fuel outlet valve assembly and replace them as needed.
--	---

3. The engine stops abruptly

Fault cause	Action
Insufficient fuel	Check the fuel tank. Add the fuel again if necessary. In addition, check the fuel system for air or leakage.
Poor nozzle	If necessary, replace the nozzle with a new one.
Lack of lubricating oil or poor lubrication, resulting in overheating moving parts	Check the amount of engine oil with an oil level gauge. Check the lubricating oil system. After every 2 oil changes, be sure to replace the oil filter element Check whether the clearance of engine bearings is within the factory specifications.

4. The color of exhaust gas is abnormal

Fault cause	Action
Damaged fuel regulating device	Contact the service personnel of LGMG.
Inferior fuel	Choose quality fuel. Please use No. 2-D diesel only.
Damaged nozzle	If necessary, replace the nozzle with a new one.
Insufficient combustion	There may be insufficient vaporization, improper injection timing, etc., which are caused by faulty fuel injection system, improperly adjusted valve, compression leakage, improper compression, etc. Check the cause of the failure.

5. Engine overheats

Fault cause	Action
Insufficient engine oil	Check the oil level. Replenish the oil if necessary.
Damaged or elongated fan belt	Replace the belt or adjust the belt tension.
Insufficient coolant	Add coolant.
High concentration of antifreeze	Change the antifreeze only with water or coolant of specified mixing ratio.
Radiator grille or radiator fins blocked by dust	Carefully clean the radiator grille or radiator fins
Corroded radiator interior or coolant circuit	Clean or replace the radiator and its parts.
Faulty fan, radiator or radiator cover	Replace the faulty components.
Faulty thermostat	Check the thermostat, and if necessary, Replace it.
Faulty thermometer or temperature sensor	Check the temperature with a thermometer and replace it if necessary.
Faulty or leaking cylinder	Replace parts.

head gasket	
Improper fuel injection timing	Adjust to the right timing
Unsuitable engine oil	Use the specified fuel.

DTCs of Kubota engine

Description of DTC	J1939-73		Error identification	DTC setting parameter
	SPN	FMI		
Accelerator pedal position sensor: high	91	3	Sensor/harness open, or +B short-circuited	Coolant temperature sensor voltage: not less than 4.9V
Accelerator pedal position sensor: low	91	4	Sensor/harness shorted to ground	Coolant temperature sensor voltage: not greater than 0.1V
Wrong oil pressure	100	1	Oil pressure switch	The oil pressure switch works
Engine overheated	110	0	Too high engine coolant temperature	Engine coolant temperature: $\geq 110^{\circ}\text{C}$
Coolant temperature sensor: high	110	3	Sensor/harness open, + B short-circuited	Coolant temperature sensor voltage: not less than 4.9 V
Coolant temperature sensor: low	110	4	Sensor/harness shorted to ground	Coolant temperature sensor voltage: not greater than 0.1 V
Battery voltage: high	158	3	Harness open, short-circuited or damaged. Battery fault	ECU identifies that battery voltage is greater than 18 V.
Engine overspeed	190	0	Engine speed above threshold	Engine speed > 2990 min ⁻¹ (rpm)
Sensor power supply voltage 1: low	3509	4	Sensor power supply voltage 1	Sensor voltage: below 4.00 V
Actuator error	523771	2	Harness open, short-circuited or damaged.	Actuator current: >3.0A or < 80mA
Abnormal engine speed sensor	523772	2	Harness open, short-circuited or damaged.	After starter signal is input to ECU, engine speed = 0 min ⁻¹ (rpm)
Starter fault	523736	2	Starter running time above threshold.	Starter running time exceeds 12 s
Alternator L terminal error	523737	2	Harness open, short-circuited or damaged.	Voltage exists in alternator L terminal at speed of 0 rpm (switch on)
Charging failure	523738	2	Harness open, short-circuited or damaged.	During engine running, alternator L terminal voltage is 0V
CAN communication error	523774	2	CAN bus	CAN bus off
Engine stop			Emergency stop button	Emergency stop CAN signal is sent to ECU

5.20 Checking or replacing the scissor arm slider

Perform this step every 1000 hours or every year, whichever comes first.

1. The quality of wear-resistant slider of scissor arm is critical to the safe operation of the machine. Worn sliders may lead to component damage and safety hazards.
2. Check the wear washer when the platform is folded.
 - a. Measure the height of wear washer on chassis slide rails and platform slide rails.

Result: The measurement result is less than 8mm/0.31in. Replace the wear-resistant slider.

- b. Apply lubricant between chassis slide rail and wear-resistant slider, and between platform slide rail and wear-resistant slider.

5.21 Scheduled maintenance

Quarterly, yearly and biennial maintenance items must be performed by qualified personnel trained on the maintenance of the machine in accordance with the procedures in the Maintenance Manual of the machine.

Machines that are not used for more than three months must be subject to quarterly inspection before put into use again.

5.22 Routine Inspection and Maintenance Intervals



Note:

The working hours are based on the engine working time, and the operation cycle is calculated from the date of production.

Maintenance Period

Maintenance level	Routine inspection	Level 1 maintenance	100h	Level 2 maintenance	Level 3 maintenance	Level 4 maintenance	Level 5 maintenance
Maintenance period	Daily	50h	100h	300h	500h	800h	1000h

Table of Maintenance Inspection Items

Sys tem	Operation, inspection and replacement items	Routine inspection	Level 1 maintenance	100h maintenance	Level 2 maintenance	Level 3 maintenance	Level 4 maintenance	Level 5 maintenance	Remarks
Power train	Check the engine oil level	•							
	Check the fuel level in the fuel tank	•							
	Check if the fuel system pipeline leaks	•							
	Check the radiator coolant level	•							
	Check if the cooling system pipeline leaks	•							
	Check the connection between the engine and the tray				•	•	•	•	
	Replace the engine oil	First 50h, thereafter every 200h (Kubota-D1105)/ 500h (DeutzD2.9L4/Kubota-V2403-E5) or every six months, whichever comes first.							At least once a year
	Replace the engine oil filter element	First 50h, thereafter every 200h (Kubota-D1105)/ 500h (DeutzD2.9L4/ Kubota-V2403-E5) or every six months, whichever comes first.							At least once a year
	Check and adjust the tightness of the fan belt		•	•	•	•	•	•	
	Clean the radiator with compressed air			•	•	•	•	•	
	Clean the fuel tank filler filter			•	•	•	•	•	
	Drain deposits from the fuel tank			•		•		•	
	Replace the fine fuel filter element	Every 400h (Kubota-D1105)/ 500h (DeutzD2.9L4/Kubota-V2403 -E5) or every six months, whichever comes first.							
	Replace the primary fuel filter element	Every 500h (Kubota-V2403-E5)/1000h (DeutzD2.9L4) or every six months, whichever comes first. If necessary (Kubota-D1105).							
Check the water level in the water separator, and drain	•								

	the water regularly for cleaning								
	Clean or replace the air cleaner outer element and inner element	Clean the air cleaner outer element every 250h or when the indicator alarms, and it is forbidden to clean the air cleaner inner element							It can be cleaned for at most 5 times generally.
	Change coolant	Every 2000h or every two years, whichever comes first.							
Electrical system	Check the battery for undervoltage	•							
	Check if the battery terminals are loose or rusted	•							
	Check the color of the battery sight hole				•	•	•	•	
	Check if buttons on the PCU panel operate normally	•							
	Check if the PCU harness connector is connected firmly	•							
	Check if the PCU harness connector is stained	•							
	Check if the PCU harness is extruded or broken	•							
	Check if the angle sensor and inclinometer are wired firmly	•							
	Check if limit switch rocker arms are wired loosely	•							
	Check the limit switches on the fork pulling plate guard plate and the stoppers for misalignment, deformation, excessive wear, etc.	•							
	Check if the forward and reverse solenoid valve connector of the walking pump is loose	•							
	Check if buttons on the ground control panel operate normally	•							
	Check if the warning lamp and horn function normally	•							
	Check if the solenoid valve coils of main valve block are wired normally or loose	•							
	Check the starter motor terminals for looseness, breakage, etc.	•							

	Check if the battery terminals are loose or rusted	•								
Hydraulic system	Check if the system pressure is normal			•	•	•	•	•		
	Check if the lifting pressure system is normal			•	•	•	•	•		
	Check if the steering system pressure is normal			•	•	•	•	•		
	Check if the traveling system pressure is normal			•	•	•	•	•		
	Check the permeability of the hydraulic oil tank exhaust cap			•	•	•	•	•		
	Check if the oil pipes and joints are loose	Daily								
	Check if the oil cylinder leaks oil	Daily								
	Check if the valve spools leak oil	Daily								
	Check if the fork oil pipe is fixed firmly	Daily								
	Check if the walking oil pipe fixing clip is loose	Daily								
	Check the oil level in the hydraulic tank	Daily								
	Replace hydraulic oil and suction filter	Every 2,000h or every two years, whichever comes first								
	Replacement of the high pressure filter element	Every 500h or every six months, whichever comes first.								
	Replace the air cleaner	Every 1,000 hours or every year, whichever comes first								
	Check the reducer for oil leakage	Daily								
	Check the walking motor for oil leakage	Daily								
Change the reducer gear oil	First 50h, thereafter every 1,000h or every year, whichever comes first.									
Replace the return oil filter element	Every 500h or every six months, whichever comes first.									
Machine	Check the machine slider for abnormal noise				•	•	•	•		
	Check the slider (replace it if necessary)		•	•	•	•	•	•		
	Check the machine bolts for looseness or abnormal noise	•								
	Check the snap springs and washers of scissor arm for failure	•								
	Check if the emergency lowering device is normal	•								

	Check the platform, fork and chassis for deformation or open weld	•							
	Check if the vehicle paint falls off	•							
	Check if the safety identification is true or stained	•							
Lu bri cati on	Lubricate the steering knuckle			•	•	•	•	•	
	Lubricate the fork slider			•	•	•	•	•	

6 Appendix

6.1 Machine fault codes

GCU display	PCU display	Description	Solution
0x01 Internal ECU Fault	01	GCU error	Replace the GCU.
0x02 Platform ECU Fault	02	Communication error	Check the wiring, and if the wiring is intact, replace the platform/ground control unit respectively to determine if the platform/ground control unit is faulty.
0x07 LOCKOUT_TWO	07	Two-stage lockout activated	Unlock via PCU
0x09 Search Status	09	Vehicle under search	This is a vehicle search prompt, and does not constitute a fault
0x0C Tilt Alarm LL	0C	Vehicle tilted	Move the vehicle to the level ground
0x0E Angle Sensor Fault	0E	Angle sensor fault	Check the wiring and angle sensor
0x0F Pressure Sensor Fault	0F	Pressure sensor fault	Check the wiring and pressure sensor
0x0F Pressure Compens Fault	10	Single channel voltage type pressure compensation sensor fault for vehicle with dual-pressure compensator	Check the wiring and pressure sensor
0x14 Chassis Start Sw Fault	14	Chassis start switch pressed during power-on	Check the switch and wiring
0x15 Chassis Choke Sw Fault	15	Chassis choke switch pressed during power-on	Check the switch and wiring
0x16 Chassis Up Sw Fault	16	Chassis UP switch pressed during power-on	Check the switch and wiring
0x17 Chassis Lift Sw Fault	17	Chassis lift switch pressed during power-on	Check the switch and wiring

0x18 Chassis Down Sw Fault	18	Chassis DOWN switch pressed during power-on	Check the switch and wiring
0x19 Left Turn Switch Fault	19	Left turn switch on PCU pressed during power-on	Check the switch and replace the PCU
0x1A Right Turn Switch Fault	1A	Right turn switch on PCU pressed during power-on	Check the switch and replace the PCU
0x1B Drive Enable Sw Flt	1B	Drive enable switch on PCU pressed during power-on	Check the switch and replace the PCU
0x1C Off Neutral Drive Joystick	1C	Drive joystick on PCU not in the neutral position during power-on	Check the joystick and replace the platform control unit
0x1D Platform LiftSwFault	1D	Lift switch on PCU pressed during power-on	Check the switch and replace the PCU
0x1E Off Neutral Lift Joystick	1E	Lift joystick on PCU not in the neutral position during power-on	Check the lift joystick and replace the PCU
0x1F Platform Choke Sw Fault	1F	Choke switch on PCU pressed during power-on	Check the switch and replace the PCU
0x20 Platform Start Sw Fault	20	Start switch on PCU pressed during power-on	Check the switch and replace the PCU
0x21 Left Front Outrig Sw Flt	21	Left front outrigger switch on PCU pressed during power-on	Check the switch and replace the PCU
0x22 Righ Front Outrig Sw Flt	22	Right front outrigger switch on PCU pressed during power-on	Check the switch and replace the PCU
0x23 Left Rear Outrig Sw Flt	23	Left rear outrigger switch on PCU pressed during power-on	Check the switch and replace the PCU

0x24 Right Rear Outrig Sw Flt	24	Right rear outrigger switch on PCU pressed during power-on	Check the switch and replace the PCU
0x25 AutoLevel Switch Fault	25	Auto level switch on PCU pressed during power-on	Check the switch and replace the PCU
0x26 Platform Walk Sw Fault	26	Walk switch on PCU pressed during power-on	Check the switch and replace the PCU
0x27 LOST_COMM_GPS (4G-TBOX Fault)	27	NVR 4G-TBOX communication interrupted with vehicle not locked	Check GCU and GPS wiring
0x28 LOST_COMM_GPS (LA-TBOX Alarm)/0x28 0x28PASSIVE_LOCK(4G-TBOX)	28	Communication between GCU and GPS interrupted (LA-TBOX) /Communication between GCU and TBOX failed and vehicle locked (4G-TBOX)	Check GCU and GPS wiring
0x29 LOCKOUT_ONE	29	One-stage lockout activated	Unlock via PCU
0x2C DOWNLIMIT SWOPENFAULT	2C	Downlimit NO contact fault	Check the connection of downlimit NO contact
0x2D DOWNLIMIT SWCLOSEFAULT	2D	Downlimit NC contact fault	Check the connection of downlimit NC contact
0x2E 9MLIMIT SW OPEN FAULT	2E	9m limit NO contact fault	Check the connection of 9m limit NO contact
0x2F 9MLIMIT SWCLOSEFAULT	2F	9m limit NC contact fault	Check the connection of 9m limit NC contact
0x34 Func Prop Coil Fault	34	Y9 proportional valve open circuit	Check the line and replace the solenoid valve
0x36 Up Coil Fault	36	Lift-up solenoid valve open circuit	Check the line and replace the solenoid valve.

0x37 Down Coil Fault	37	Lift-down solenoid valve open circuit	Check the line and replace the solenoid valve.
0x38 Right Turn Coil Fault	38	Right turn solenoid valve open circuit	Check the line and replace the solenoid valve.
0x39 Left Turn Coil Fault	39	Left turn solenoid valve open circuit	Check the line and replace the solenoid valve.
0x3A Brake Coil Fault	3A	Brake release solenoid valve open circuit	Check the line and replace the solenoid valve.
0x42 Low Oil Pressure	42	Low oil pressure	Check the wiring and replace the engine oil pressure switch
0x43 High Coolant Temperature	43	High engine coolant temperature	Check the wiring and replace the engine water temperature switch
0x45 Low Engine RPM	45	Engine rpm low	Check the line and the engine.
0x46 High Engine RPM	46	Engine rpm high	Check the line and the engine.
0x47 RFLIMIT SWCLOSEFAULT	47	Right front outrigger NC contact fault	Check the travel switch and harness
0x48 RFLIMIT SWOPENFAULT	48	Right front outrigger NO contact fault	Check the travel switch and harness
0x49 RRLIMIT SWCLOSEFAULT	49	Right rear outrigger NC contact fault	Check the travel switch and harness
0x4A RRLIMIT SWOPENFAULT	4A	Right rear outrigger NO contact fault	Check the travel switch and harness

0x4B LFLIMIT SWCLOSEFAULT	4B	Left front outrigger NC contact fault	Check the travel switch and harness
0x4C LFLIMIT SWOPENFAULT	4C	Left front outrigger NO contact fault	Check the travel switch and harness
0x4D LRLIMIT SWCLOSEFAUL	4D	Left rear outrigger NC contact fault	Check the travel switch and harness
0x4E LRLIMIT SWOPENFAULT	4E	Left rear outrigger NO contact fault	Check the travel switch and harness
0x50 Left Front OtrgCoilFlt	50	Left front outrigger solenoid valve open circuit	Check the line and replace the solenoid valve.
0x51 Left Rear OtrgCoilFlt	51	Left rear outrigger solenoid valve open circuit	Check the line and replace the solenoid valve.
0x52 Right Front OtrgCoilFlt	52	Right front outrigger solenoid valve open circuit	Check the line and replace the solenoid valve.
0x53 Right Rear OtrgCoilFlt	53	Right rear outrigger solenoid valve open circuit	Check the line and replace the solenoid valve.
0x54 Outrigger Ext Coil Flt	54	Outrigger extension solenoid valve open circuit	Check the line and replace the solenoid valve.
0x55 Outrigger Ret Coil Flt	55	Outrigger retraction solenoid valve open circuit	Check the line and replace the solenoid valve.
0x57 DPF Fault Lv3 RegeneratonNeeded	57	DPF level 3 alarm activated	Operate the engine after-treatment system
0x58 DPF Fault Lv4 RegeneratonNeeded	58	DPF level 4 alarm activated	Operate the engine after-treatment system

0x59 DPF Fault Lv5 RegeneratonNeeded	59	DPF level 5 alarm activated	Operate the engine after-treatment system
0x5A 2Speed Coil Fault	5A	High/low-speed solenoid valve open circuit	Check the line and replace the solenoid valve.
0x5B Bypass Coil Fault	5B	Bypass solenoid valve short circuit	Check the line and replace the solenoid valve.
0x5C Drive Fwd Prop Coil Fault	5C	Drive forward solenoid valve open circuit	Check the line and replace the solenoid valve.
0x5D Drive Rev Prop Coil Fault	5D	Drive reverse solenoid valve open circuit	Check the line and replace the solenoid valve.
0x5E Machine Type Fault	5E	Model error	Reselect the correct model
0x5F Low Fuel Level	5F	Fuel level low	Check the remaining fuel level in the fuel tank, and add fuel if necessary
0x60 FreeWheel Coil Fault	60	Freewheel valve open circuit	Check the line and replace the solenoid valve.
0x61 ACCUM Coil Fault	61	ACCUM solenoid valve open circuit	Check the line and replace the solenoid valve.
0x62 HBY Coil Fault	62	High-speed bypass valve open circuit	Check the line and replace the solenoid valve.
0x63 Platform Overload	63	Platform overloaded	Check the line and reduce the platform load
0x64 DPF Fault Lv6 RegenerationNeeded	64	DPF level 6 alarm activated	Operate the engine after-treatment system

0X65 Beacon Fault	65	Engine fault	Refer to the engine maintenance manual Do troubleshooting based on SPN and FMI
0x66 BPSCDNP	66	Engine intake pressure sensor fault	Check the engine connector or sensor, or refer to the engine maintenance manual
0x67 APP2SRC	67	Engine accelerator pedal fault	Check the engine connector or sensor, or refer to the engine maintenance manual
0x68 OPSCD	68	Engine oil pressure error	Check the engine connector or sensor, or refer to the engine maintenance manual
0x69BPSCD	69	Engine intake pressure sensor fault	Check the engine connector or sensor, or refer to the engine maintenance manual
0x6A IATSCDSRC	6A	Intake temperature sensor fault	Check engine connector or sensor, or refer to the engine maintenance manual
0x6B CTSCD	6B	Water temperature sensor fault	Check engine connector or sensor, or refer to the engine maintenance manual
0x6C RAILCDOFSTST	6C	Rail pressure sensor fault	Check engine connector or sensor, or refer to the engine maintenance manual
0x6D BATTCDSRC	6D	Battery voltage error	Check the engine connector or sensor, or refer to the engine maintenance manual
0x6E OTSCD	6E	Oil temperature sensor fault	Check engine connector or sensor, or refer to the engine maintenance manual
0x6F INJINI	6F	INJdriverIC initialization version number error	Check engine connector or sensor, or refer to the engine maintenance manual
0x70 MSSCD	70	PTO switch signal error	Check engine connector or sensor, or refer to the engine maintenance manual

0x71 TECUSRC	71	ECU temperature sensor fault	Check engine connector or sensor, or refer to the engine maintenance manual
0x72 INJVLVCYL1	72	Injector 1 fault	Check engine connector or sensor, or refer to the engine maintenance manual
0x73 INJVLVCYL2	73	Injector 2 fault	Check engine connector or sensor, or refer to the engine maintenance manual
0x74 INJVLVCYL3	74	Injector 3 fault	Check engine connector or sensor, or refer to the engine maintenance manual
0x75 INJVLVCYL4	75	Injector 4 fault	Check engine connector or sensor, or refer to the engine maintenance manual
0x76 MEUNCD	76	Fuel gauge fault	Check engine connector or sensor, or refer to the engine maintenance manual
0x77 ENGSPD	77	Engine speed signal failure	Check engine connector or sensor, or refer to the engine maintenance manual
0x78 FANCDSP	78	Cooling fan speed error	Check engine connector or sensor, or refer to the engine maintenance manual
0x79 STRTCDLSSC	79	Starter motor relay fault	Check engine connector or sensor, or refer to the engine maintenance manual
0x7A ENGRPTOVRSPD	7A	Engine speed high	Check engine connector or sensor, or refer to the engine maintenance manual
0x7B HWEMONEEPROM	7B	EEPROM read error	Check engine connector or sensor, or refer to the engine maintenance manual
0x7C AIRHT	7C	Intake heater normally open	Check engine connector or sensor, or refer to the engine maintenance manual

0x7D ENGMCAS	7D	Camshaft signal loss	Check engine connector or sensor, or refer to the engine maintenance manual
0x7E ENGMCRS	7E	Crankshaft signal loss	Check engine connector or sensor, or refer to the engine maintenance manual
0x7FCOMT50ST	7F	DEC1 message T50 signal receiving error	Check engine connector or sensor, or refer to the engine maintenance manual
0x80GEARDETERR	80	Abnormal working of idle sleep switch when ECU is powered on	Check engine connector or sensor, or refer to the engine maintenance manual
0x81 ECBTCDPLAUS	81	Chassis start/stop switch stuck	Check engine connector or sensor, or refer to the engine maintenance manual
0x82 FRMMNGTRF1	82	CAN received frame TRF1 data size error	Check engine connector or sensor, or refer to the engine maintenance manual
0x83 COMGPSDRV	83	Duration with engine speed at 0 exceeding a certain value when T15 is not powered off	Check engine connector or sensor, or refer to the engine maintenance manual
0x84 RAILME	84	Fuel level indicated by the fuel gauge above the threshold	Check engine connector or sensor, or refer to the engine maintenance manual
0x85 NETMNGCANA	85	CAN communication error	Check engine connector or sensor, or refer to the engine maintenance manual
0x86 FRMMNGEBC1	86	CAN received frame EBC1 data length error	Check engine connector or sensor, or refer to the engine maintenance manual
0x87 FRMMNGEBC2	87	Data length error	Check engine connector or sensor, or refer to the engine maintenance manual
0x88 MNGENGTEMP2	88	CAN received frame EngTemp2 data size error	Check engine connector or sensor, or refer to the engine maintenance manual

0x89 FRMMNGERC1DR	89	CAN received frame ERC1DR data size error	Check engine connector or sensor, or refer to the engine maintenance manual
0x8A FRMMNGETC1	8A	ETC1 message data length error	Check engine connector or sensor, or refer to the engine maintenance manual
0x8B FRMMNGETC2	8B	CAN received frame ETC2 data size error	Check engine connector or sensor, or refer to the engine maintenance manual
0x8C FRMMNGRXCCVS	8C	RxCCVS message data length error	Check engine connector or sensor, or refer to the engine maintenance manual
0x8D FRMMNGTCO1	8D	CAN received frame TCO1 data length error	Check engine connector or sensor, or refer to the engine maintenance manual
0x8E FRMMNGTSC1AE	8E	CAN received frame TSC1AE data size error	Check engine connector or sensor, or refer to the engine maintenance manual
0x8F FRMMNGTSC1AR	8F	CAN received frame TSC1AR data size error	Check engine connector or sensor, or refer to the engine maintenance manual
0x90 FRMMNGTSC1DE	90	CAN received frame TTSC1DE data size error	Check engine connector or sensor, or refer to the engine maintenance manual
0x91 FRMMNGTSC1DR	91	CAN received frame TSC1DR data size error	Check engine connector or sensor, or refer to the engine maintenance manual
0x92 FRMMNGTSC1PE	92	CANTOTSC1PE data size error	Check engine connector or sensor, or refer to the engine maintenance manual
0x93 FRMMNGTSC1TE	93	CANTOTSC1TE data size error	Check engine connector or sensor, or refer to the engine maintenance manual
0x94 FRMMNGTSC1TR	94	CANTOTSC1TR data size error	Check engine connector or sensor, or refer to the engine maintenance manual

0x95 FRMMNGTSC1VE	95	CANTOTSC1VE data size error	Check engine connector or sensor, or refer to the engine maintenance manual
0x96 FRMMNGTSC1VR	96	CANTOTSC1VR data size error	Check engine connector or sensor, or refer to the engine maintenance manual
0x97FRMMNGHRVD	97	CAN received frame HRVD data size error	Check engine connector or sensor, or refer to the engine maintenance manual
0x98 FRMMNGDASHDSP	98	CAN received frame DashDspl data size error	Check engine connector or sensor, or refer to the engine maintenance manual
0x99 FRMMNGEGF1	99	CAN received frame EGF1 data size error	Check engine connector or sensor, or refer to the engine maintenance manual
0x9A FRMMNGCM1DLC	9A	CAN received frame CM1 data size error	Check engine connector or sensor, or refer to the engine maintenance manual
0x9B FRMMNGDEC1	9B	CAN received frame DEC1 data size error	Check engine connector or sensor, or refer to the engine maintenance manual
0x9C FRMMNGETC7	9C	CAN received frame ETC7 data size error	Check engine connector or sensor, or refer to the engine maintenance manual
0x9D FRMMNGAPP	9D	Bus received throttle signal out of limit	Check engine connector or sensor, or refer to the engine maintenance manual
0x9E FRMMNGREMAPP	9E	Bus received remote throttle signal out of limit	Check engine connector or sensor, or refer to the engine maintenance manual
0x9F COMGPS	9F	DEC1 message T50 signal receiving error	Check engine connector or sensor, or refer to the engine maintenance manual
0xA0 GENERFAULT	A0	Alternator fault	Check engine connector or sensor, or refer to the engine maintenance manual

0xA1 BATTVLTGERR	A1	High battery voltage	Check engine connector or sensor, or refer to the engine maintenance manual
0xA2 ENGOVERHEAT	A2	Engine overheating	Check engine connector or sensor, or refer to the engine maintenance manual
0xA3 WATERTEMPHIGH	A3	High engine water temperature	Check engine connector or sensor, or refer to the engine maintenance manual
0xA4 WATERTEMPLOW	A4	Low engine water temperature	Check engine connector or sensor, or refer to the engine maintenance manual
0xA5 BATVOL_HIGH	A5	High battery voltage	Check engine connector or sensor, or refer to the engine maintenance manual
0xA6 ENGOVERRUN	A6	Engine overspeed	Check engine connector or sensor, or refer to the engine maintenance manual
0xA7 SENVOLT_LOW	A7	Low sensor voltage	Check engine connector or sensor, or refer to the engine maintenance manual
0xA8 ACTUATORFAULT	A8	Abnormal brake	Check engine connector or sensor, or refer to the engine maintenance manual
0xA9 SPEEDSENFALT	A9	Speed sensor fault	Check engine connector or sensor, or refer to the engine maintenance manual

6.2 Electrical schematic diagram

6.2.1 SR18D Electrical schematic diagram

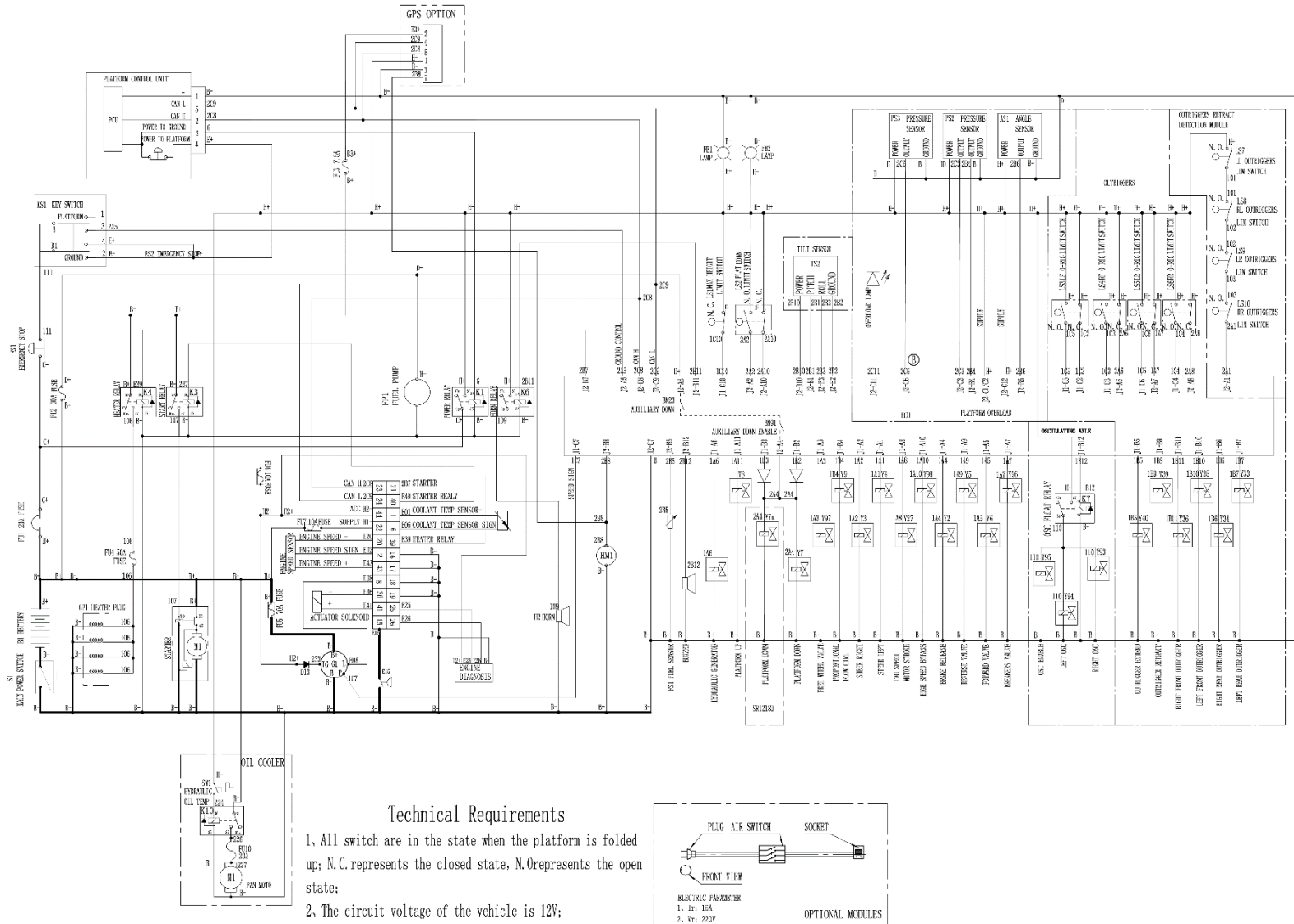

6.3 Hydraulic schematic diagram



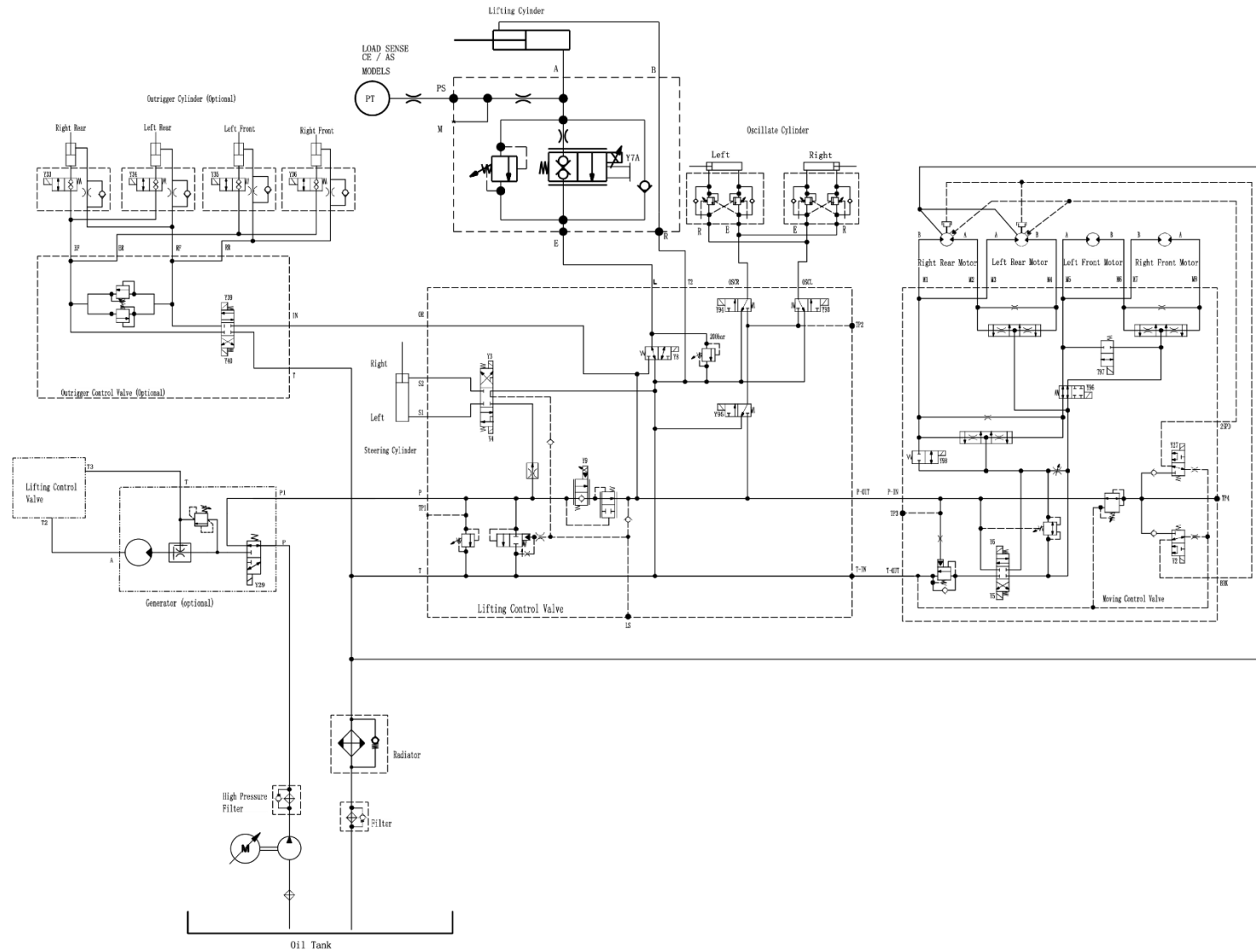



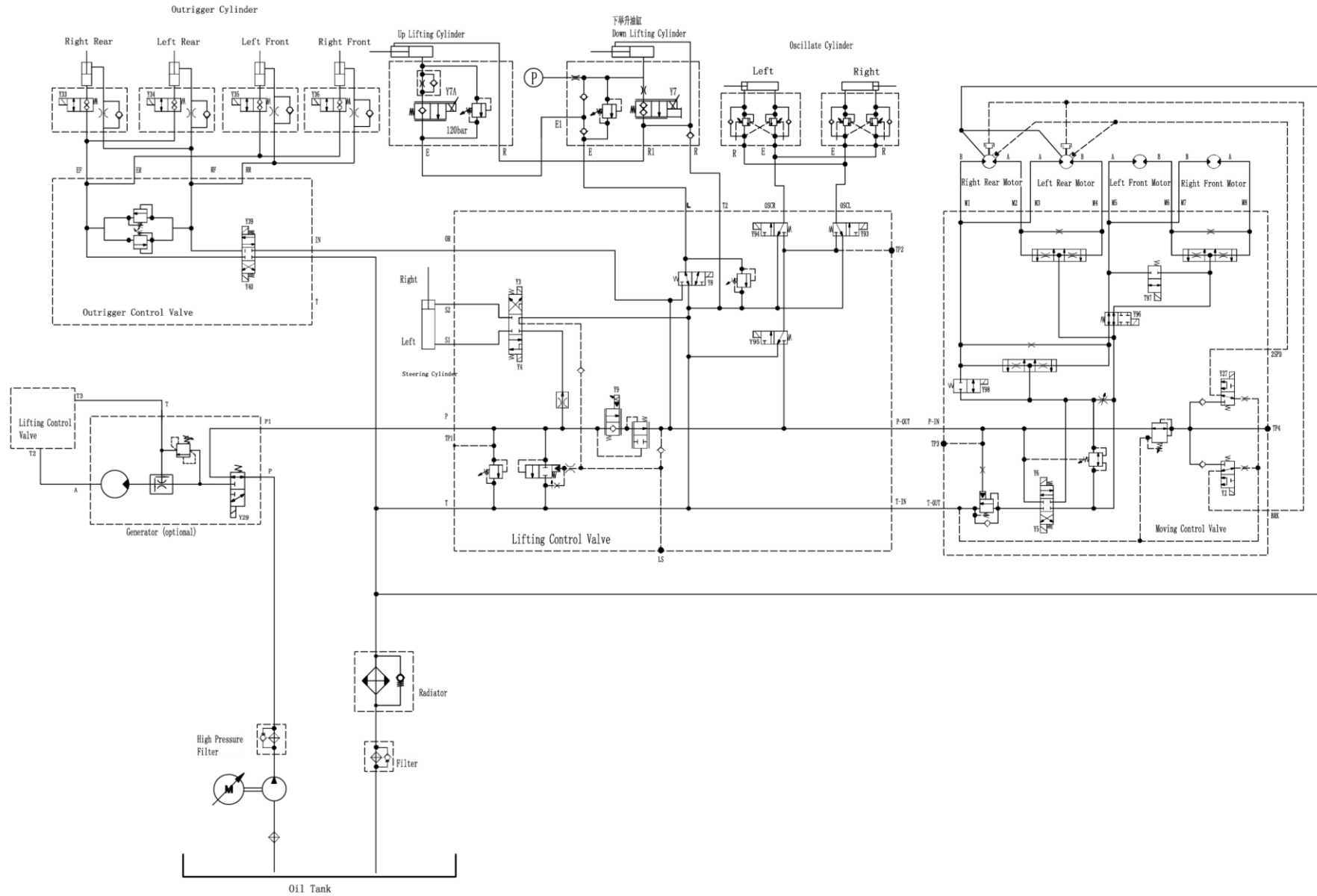



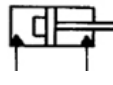

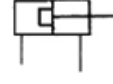



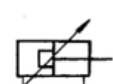

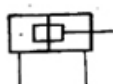

6.3.1 SR0818D、SR1018D Hydraulic schematic diagram

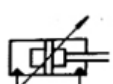







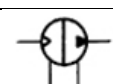





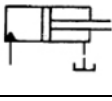

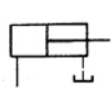
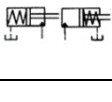
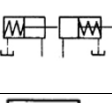
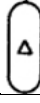
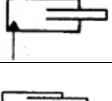



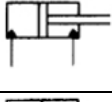

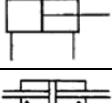

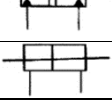

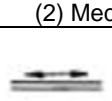

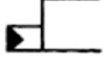

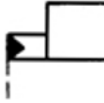

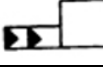



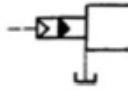

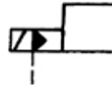



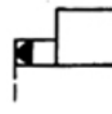

6.3.2 SR1218D Hydraulic schematic diagram



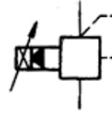

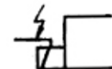

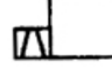

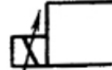

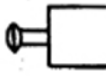

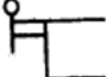
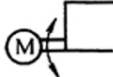

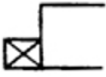

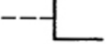



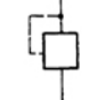
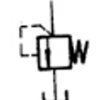

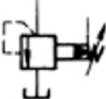
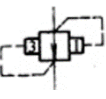
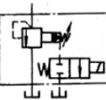

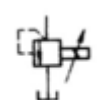

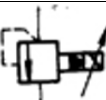
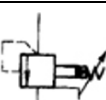
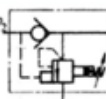
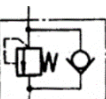



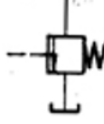

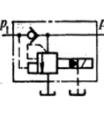
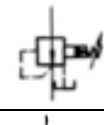
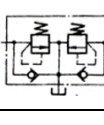
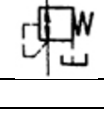
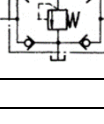

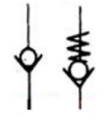

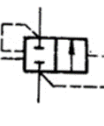
6.4 Diagram of common hydraulic part symbols

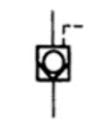

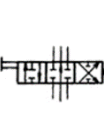

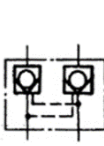
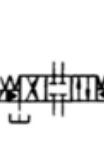
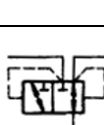

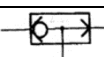





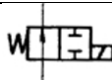

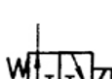

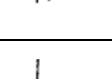
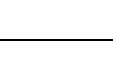
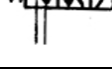







(1) Hydraulic pump, hydraulic motor and hydraulic cylinder						
Name	Symbol	Description	Name	Symbol	Description	
Hydraulic pump		General symbol	Double-acting cylinder		Detailed symbol	
		One-way rotation, one-way flow and fixed displacement			Simplified symbol	
		Two-way rotation, two-way flow, fixed displacement			Detailed symbol	
		One-way rotation, two-way flow, variable displacement			Simplified symbol	
		Two-way rotation, two-way flow, variable displacement			Detailed symbol	
Hydraulic motor		General symbol	Adjustable two-way bounce cylinder		Simplified symbol	
		One-way flow, one-way rotation			Detailed symbol	
		Two-way flow, two-way rotation, fixed displacement			Simplified symbol	
		One-way flow, one-way rotation, variable displacement	Telescopic bar			
		Two-way flow, two-way rotation, variable displacement		Pressure converter		One-way action
		Two-way swing, fixed angle				Continuous action



















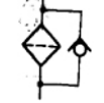

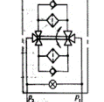







Pump-motor	Fixed displacement hydraulic pump-motor		One-way flow, one-way rotation, fixed displacement	Turbocharger		One-way action	
	Variable displacement hydraulic pump-motor		Two-way flow, two-way rotation, variable displacement, external oil drain			Continuous action	
	Hydraulic integral transmission		Unidirectional rotation, variable displacement, fixed displacement motor			Accumulator	
Single-acting cylinder	Single piston rod cylinder		Detailed symbol	Accumulator			
			Simplified symbol				Weight-loaded type
	Single piston rod cylinder (with return spring)		Detailed symbol				
			Simplified symbol	Auxiliary gas cylinder			
	Plunger rod cylinder			Gas tank			
	Telescopic cylinder			Energy source	Hydraulic pressure source		General symbol
Double-acting cylinder	Single piston rod cylinder		Detailed symbol		Air pressure source		General symbol
			Simplified symbol		Motor		
Double piston rod cylinder	Double piston rod cylinder		Detailed symbol	Prime motor		Except motor	
			Simplified symbol				
(2) Mechanical control device and control methods							
Mechanical control parts	Straight moving rod		Arrows can be omitted	Pilot pressure control method	Hydraulic pilot pressure control		Internal pressure control
	Axle of rotary motion		Arrows can be omitted		Hydraulic pilot pressure control		External pressure control
	Positioning device				Hydraulic secondary pilot		Internal pressure control,







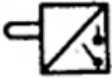



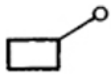

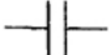

					pressure control		internal oil drain
	Locking device		* Control method for unlocking		Gas-liquid pilot pressure control		External control of air pressure, hydraulic internal control, external oil drain
	Bounce mechanism				Electro-hydraulic pilot pressure control		Hydraulic external control, internal oil drainage
	Ejector rod type				Hydraulic pilot pressure relief control		Internal pressure control, internal oil drain
	Variable travel control type						External pressure control (with remote relief outlet)
	Spring control type				Electro-hydraulic pilot control		Electromagnet control, external pressure control, external oil drain
	Roller type		Two-direction operation		Pilot pressure control valve		With pressure regulating spring, external oil drain and with remote relief outlet
	One-way roller type		It's only operated in one direction, so the arrow can be omitted.		Pilot proportional solenoid pressure control valve		Priority is controlled by proportional electromagnet with internal oil drainage
Manual control method	Manual control		General symbol	Electrical control method	Single-acting electromagnet		The electrical lead can be omitted, and the slash can also be directed to the lower right.
	Button type				Double-acting electromagnet		
	Button type				Single-acting adjustable electromagnetic operation (proportional electromagnet)		

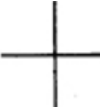
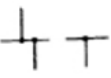
	Press-pull type				Double-acting adjustable electromagnetic operation (torque motor, etc.)		
	Handle type				Rotary motion electrical control device		
	One-way pedal type			Feedback control method	Feedback control		General symbol
	Two-way pedal type				Electrical feedback		The position is detected by potentiometer, differential transformer, etc.
	Pressurization or relief control				Internal mechanical feedback		Such as follower valve profiling control circuit
	Differential control						
	Internal pressure control		The control channel is inside the original				
	External pressure control		The control channel is outside the original				
(3) Pressure controller							
Relief valve	Relief valve		General symbols or direct-acting relief valve	Pressure reducing valve	Pilot proportional solenoid pressure reducing valve		
	Pilot relief valve				Proportional pressure reducing valve		Pressure reducing ratio: 1/3
	Pilot electromagnetic relief valve		(Normally closed)		Constant difference pressure reducing valve		
	Direct-acting proportional relief valve			Sequence valve	Sequence valve		General symbols or harmonious-acting sequence valve
	Pilot proportional relief valve				Pilot sequence valve		
	Unloading relief valve		Unloading it when $p_2 > p_1$		One-way sequence valve (balance valve)		





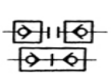

	Two-way relief valve		Direct-acting, external oil drain		Unloading valve		General symbols or direct-acting unloading valve
Pressure reducing valve	Pressure reducing valve		General symbols or direct-acting pressure reducing valve	Unloading valve	Pilot electromagnetic unloading valve		$p_1 > p_2$
	Pilot pressure reducing valve				Brake valve	Double overflow brake valve	
	Relief pressure reducing valve			Overflow oil bridge brake valve			
(4) Directional control valve							
Check valve	Check valve		Detailed symbol	Reversing valve	Two-position five-way hydraulic valve		
			Simplified symbol (spring can be omitted)		Two-position four-way motorized valve		
Hydraulic check valve	Hydraulically controlled check valve		Detailed symbol (controlling pressure shutoff valve)		Three-position four-way solenoid valve		
			Simplified symbol		Three-position four-way electro-hydraulic valve		Simplified symbol (internal leakage and external control)
			Detailed symbol (controlling pressure opening valve)		Three-position six-way hand valve		
			Simplified symbol (spring can be omitted)		Three-position five-way solenoid valve		
			Double hydraulically controlled check valve		Three-position four-way electro-hydraulic valve		External control and internal leakage (with manual emergency control device)
Shuttle valve	Or gate valve		Detailed symbol		Three-position four-way proportional valve		Throttling type, overlapped center
			Simplified symbol		Three-position		Underlapped center



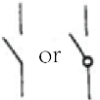

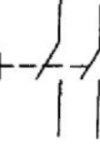

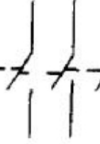

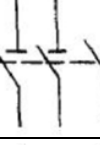
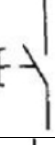
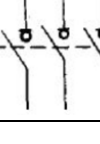
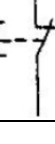

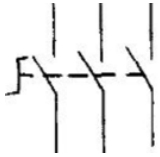
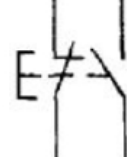
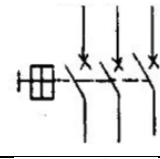

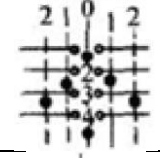
					four-way proportional valve			
Reversing valve	Two-position two-way solenoid valve		Normally closed		Two-position four-way proportional valve			
			Normally open		Four-way servo valve			
	Two-position three-way solenoid valve				Four-way electro-hydraulic servo valve		Level 2	
	Two-position three-way solenoid ball valve						Live feedback level 3	
	Two-position four-way solenoid valve							
(5) Flow control valve								
Throttle valve	Adjustable throttle valve		Detailed symbol	Flow regulating valve	Flow regulating valve		Simplified symbol	
			Simplified symbol		Bypass type flow regulating valve		Simplified symbol	
	Non-adjustable throttle valve		General symbol		Temperature compensated flow regulating valve		Simplified symbol	
	One-way throttle valve				One-way flow regulating valve		Simplified symbol	
	Double one-way throttle valve				Synchronous valve	Flow divider valve		
	Stop valve					One-way flow divider valve		
	Roller-controlled throttle valve (deceleration valve)					Flow combiner valve		
Flow regulating valve	Flow regulating valve		Detailed symbol	Diverter collector valve				
(6) Oil tank								
Atmospheric type	Pipe end above the liquid level			Oil tank	Pipe end at the bottom of the oil			

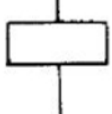
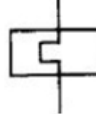
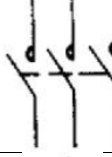

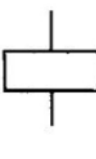

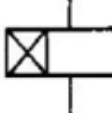
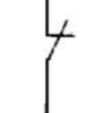
	Pipe end above the liquid level		With air cleaner		tank Local oil drain or return		
				Pressurized oil tank or closed oil tank			Three oil circuits
(7) Fluid regulator							
Filter	Filter		General symbol	Air cleaner			
	Filter with pollution indicator			Temperature regulator			
	Magnetic filter			Cooler	Cooler		General symbol
	Filter with bypass valve				Cooler to the coolant pipeline		
	Duplex filter		P1: oil inlet P2: oil return	Heater			General symbol
Pressure detector	Pressure indicator			Flow detector	Galvanometer (liquid flow indicator)		
	Pressure gauge				Flowmeter		
	Electric contact pressure gauge (pressure display controller)				Accumulated flowmeter		
	Differential pressure control gauge			Thermometer			
Level gauge			Tachometer				
				Torque meter			
(9) Other auxiliary components							
Pressure relay (pressure switch)		Detailed symbol	Differential pressure switch				
		General symbol	Sensor	Sensor			General symbol
Travel switch		Detailed symbol		Pressure sensor			

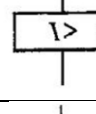
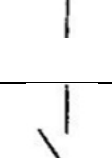

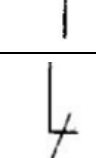
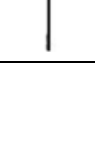

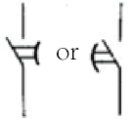
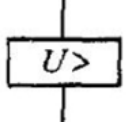
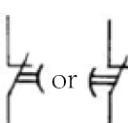
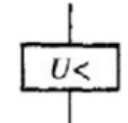
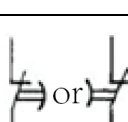

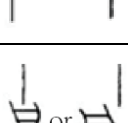
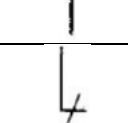
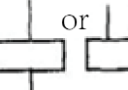
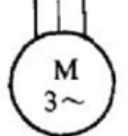
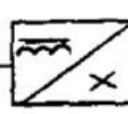
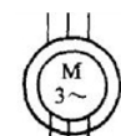
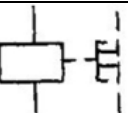
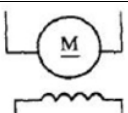
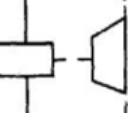
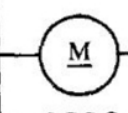
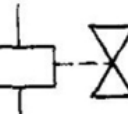
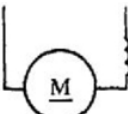
			General symbol		Temperature sensor		
Coupling	Coupling		General symbol	Amplifier			
	Flexible coupling						
(10) Pipeline, pipeline joints and connectors							
Pipeline	Pipeline		Pressure pipeline and return pipeline	Pipeline	Cross pipeline		The two pipelines are crossed and unconnected
	Control pipeline		Two pipelines intersected and connected		Flexible pipeline		
	Control pipeline		It can represent an oil draining pipeline		One-way air bleeder		
Quick-change connector	Quick connector without check valve			Rotary connector	Single-channel rotary connector		
	Quick connector with check valve				Three-way rotary connector		

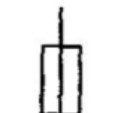
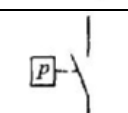
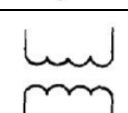
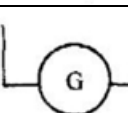
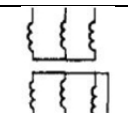
6.5 Diagram of common electrical part symbols

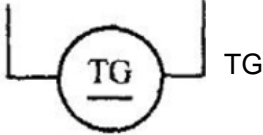
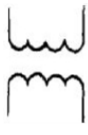
Socket	Name	Graphic symbol	Letter symbol	Category	Name	Graphic symbol	Letter symbol
Switch	Unipolar control switch		SA	Position switch	Normally open contact		SQ
	General symbols of manual switch		SA		Normally closed contact		SQ
	Three-level control switch		QS		Composite contact		SQ
	Three-level isolating switch		QS	Button	Normally open button		SB
	Three-level load switch		QS		Normally closed button		SB

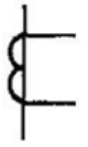
	Combination knob switch		QS		Composite button		SB
	Low voltage circuit breaker		QF		Emergency stop button		SB
	Controller or operating switch		SA		Key-operated button		SB
Contactor	Coil operating device		KM	Thermal relay	Thermal element		FR
	Normally open main contact		KM		Normally closed contact		FR
	Normally open auxiliary contact		KM	Intermediate relay	Coil		KA
	Normally closed auxiliary contact		KM		Normally open contact		KA
Time relay	Power-on delay (slow pull-in) coil		KT	Current relay	Normally closed contact		KA
	Power-off delay (slow release) coil		KT		Overcurrent coil		KA
	Normally open contact which is instantaneously closed		KT		Undercurrent coil		KA
	Normally closed contact which is instantaneously		KT		Normally open contact		KA
					Normally closed contact		KA

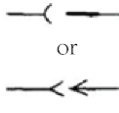
	disconnected						
	Normally open contact which is closed with delay		KT	Voltage relay	Overvoltage coil		KV
	Normally closed contact which is disconnected with delay		KT		Undervoltage coil		KV
	Normally closed contact which is closed with delay		KT		Normally open contact		KV
	Normally open contact which is disconnected with delay		KT		Normally closed contact		KV
Electromagnetic operator	General symbol of electromagnet		YA	Motor	Three-phase cage asynchronous motor		M
	Electromagnetic chuck		YH		Three-phase wound rotor asynchronous motor		M
	Electromagnetic clutch		YC		Separately excited DC motor		M
	Electromagnetic brake		YB		Shunt DC motor		M
	Solenoid valve		YV		Series DC motor		M
Non-electricity-controlled relay	Speed relay normally open contact		KS	Fuse	Fuse		FU
	Pressure relay normally open contact		KP	Transformer	Single-phase transformer		TC
Generator	Generator		G		Three-phase transformer		TM

	DC tachometer generator		TG	Transformer	Voltage transformer		TV
Lamp	Signal lamp (indicator lamp)		HL		Current transformer		TA
	Lighting lamp		EL	Connector	Plug and socket	 or 	X Plug XP Socket et XS